

## U.K. IGNITION CARTRIDGE, MK 1/1

Ordnance used with:  
MK 1/1, 2 INCH, TP, MORTAR  
MK 2/1, 2 INCH, ILLUMINATION, MORTAR  
MK 2/2, 2 INCH, SMOKE, MORTAR



---

## YUGOSLAV CARTRIDGE, 20-MM, HE-T, M57

Ordnance used with:  
UT M57, PROJECTILE, PDS  
UTM57-SM, PROJECTILE, PDS

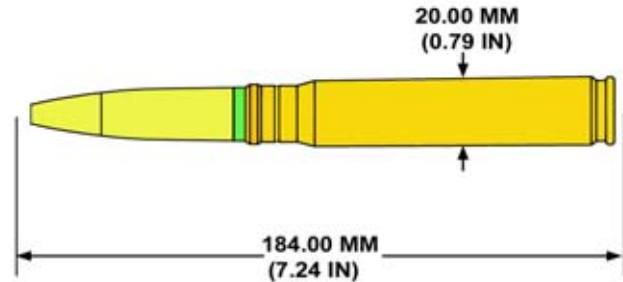

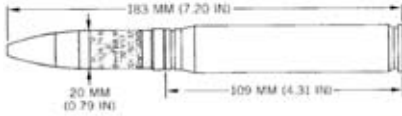

## YUGOSLAV CARTRIDGE, 20-MM, HEI, M57

Ordnance used with:  
 UT M57, PROJECTILE, PDS  
 UTM57-SM, PROJECTILE, PDS  
 T/3C, 20-MM, HEI  
 M55, AIR DEFENSE GUN, 20MM, TRIPLE BARREL  
 M75, AIR DEFENSE GUN, 20MM, TOWED  
 BOV-3, AIR DEFENSE GUN, 20MM, SELF-PROPELLED

N.E.W. 43.50 G

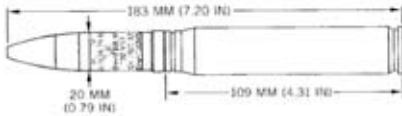

Y1 M57 CM TK	YTM57 CM TK
C47628 28 BK	C47624 BK
51C	20mm
20mmT3M57	M57
130 M57	LOI NO. 1270
C47628 28 BK	20mmT3M57
C47628 28 BK	C47628 TK
DOMESTIC	EXPORT

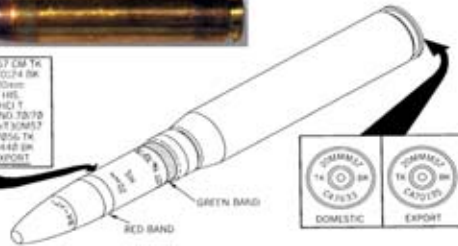

## YUGOSLAV CARTRIDGE, 20-MM, HEI-T, M57

Ordnance used with:  
 UT M57, PROJECTILE, PDS  
 UTM57-SM, PROJECTILE, PDS  
 M57, 20 MM, HEI-T  
 TZO, M57  
 T/3C, 20 MM, HEI-T  
 M55, AIR DEFENSE GUN, 20MM, TRIPLE BARREL  
 M75, AIR DEFENSE GUN, 20MM, TOWED

N.E.W. 44.50 G

## YUGOSLAV PROJECTILE, 20-MM, AP-T, M60

Ordnance used with:  
M60, CARTRIDGE, 20MM X 110MM, AP-T

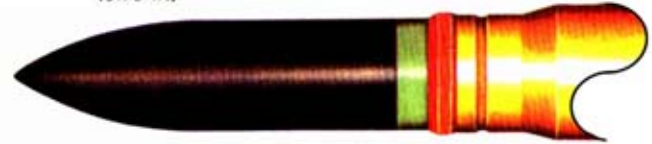
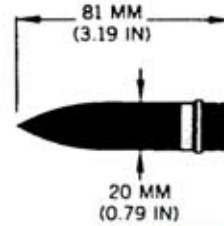

---

## YUGOSLAV PROJECTILE, 20-MM, API-T, M60

Ordnance used with:  
M60, CARTRIDGE, 20MM X 110MM, API-T

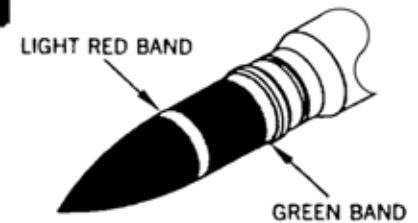
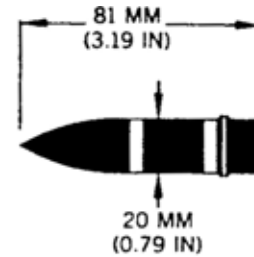

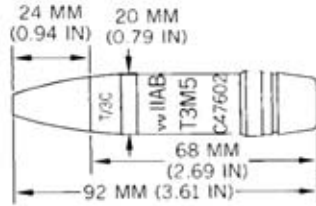

## YUGOSLAV PROJECTILE, 20-MM, HEI, M57

Ordnance used with:

UT M57, PROJECTILE, PDS

UTM57-SM, PROJECTILE, PDS

T/3C, 20-MM, HEI

M55, AIR DEFENSE GUN, 20MM, TRIPLE BARREL

M75, AIR DEFENSE GUN, 20MM, TOWED

BOV-3, AIR DEFENSE GUN, 20MM, SELF-PROPELLED

N.E.W. 43.50 G

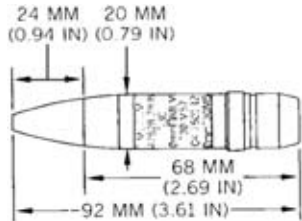

## YUGOSLAV PROJECTILE, 20-MM, HEI-T, M57

Ordnance used with:

UT M57, PROJECTILE, PDS

UTM57-SM, PROJECTILE, PDS

M57, 20-MM, CARTRIDGE, HEI-T (20MM X 110MM)

TZO M57

N.E.W. 8.50 G

## U.S.S.R. CARTRIDGE, 23-MM, API-T MODEL BZT

Ordnance used with:  
BZT, 23-MM, API-T  
ZUR-23-2S, GUN/MISSILE AIR DEFENSE SYSTEM, 23MM, TOWED  
ZU-23, AIR DEFENSE GUN, 23MM, TWIN, TOWED  
ZSU-23-4, AIR DEFENSE GUN, 23MM, QUAD, SELF-PROPELLED  
SKYWIPE, AIR DEFENSE GUN, 23MM, TWIN, TOWED



## U.S.S.R. PROJECTILE, 23-MM, API, MODEL BZA-23

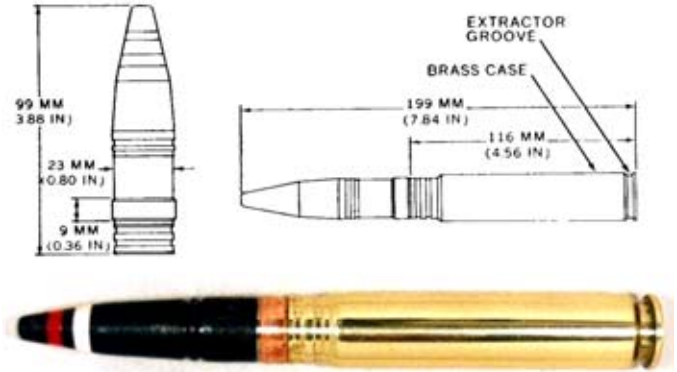

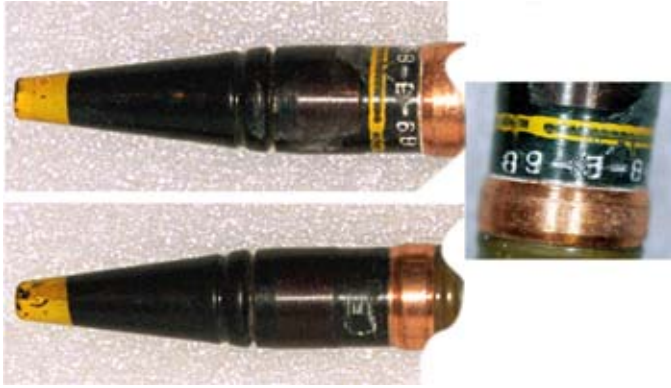

### U.S.S.R. PROJECTILE, 23-MM, API-T MODEL BZT

Ordnance used with:  
BZT, 23MM X 152BMM, CARTRIDGE, API-T

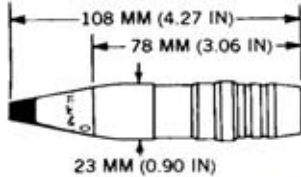

### U.S.S.R. PROJECTILE, 23-MM, FRAG-HEIT, MODEL OFZT

Ordnance used with:  
OFZT, CARTRIDGE, 23MM X 152BMM, FRAG-HEIT  
MG-25, FUZE, PROJECTILE, PDSD  
B-23M, PROJECTILE, PD



N.E.W. 13.00 G

## U.S.S.R. PROJECTILE, 23-MM, HEI-FRAG, OFZ

Ordnance used with:  
V-19U, PROJECTILE, PSD  
OFZ, CARTRIDGE, 23-MM, HEI, (23MM X 152MM)  
V19UK, PROJECTILE, PSD  
B-23M, PROJECTILE, PD

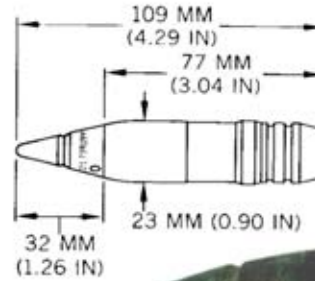

N.E.W. 19.00 G

## YUGOSLAV PROJECTILE, TRAINING, SUBCALIBER, M62

Ordnance used with:  
MODEL UNKNOWN, PD, PROJECTILE, PRACTICE

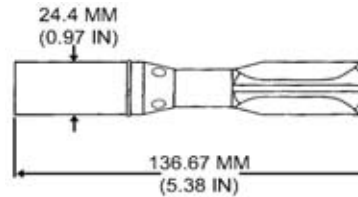

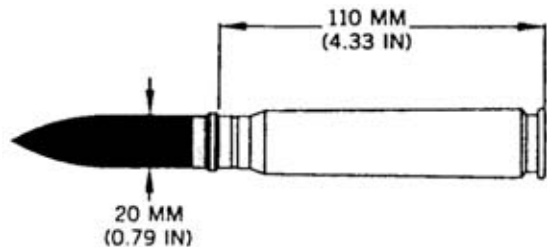

### YUGOSLAV CARTRIDGE, 20-MM, AP-T, M60

Ordnance used with:  
M60, 20 MM, APT  
M55, AIR DEFENSE GUN, 20MM, TRIPLE BARREL  
M75, AIR DEFENSE GUN, 20MM, TOWED  
BOV-3, AIR DEFENSE GUN, 20MM, SELF-PROPELLED

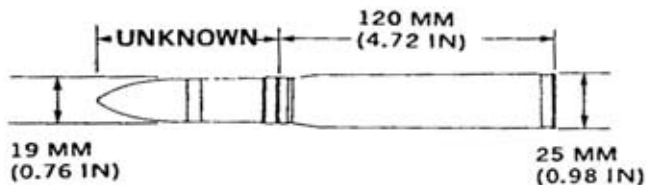

### YUGOSLAV CARTRIDGE, 20-MM, API, M60

Ordnance used with:  
M60, 20 MM, API  
M55, AIR DEFENSE GUN, 20MM, TRIPLE BARREL  
M75, AIR DEFENSE GUN, 20MM, TOWED  
BOV-3, AIR DEFENSE GUN, 20MM, SELF-PROPELLED





## YUGOSLAV CARTRIDGE, 20-MM, API-T, M60

Ordnance used with:  
M60, 20-MM, API-T  
M55, AIR DEFENSE GUN, 20MM, TRIPLE BARREL  
M75, AIR DEFENSE GUN, 20MM, TOWED  
BOV-3, AIR DEFENSE GUN, 20MM, SELF-PROPELLED

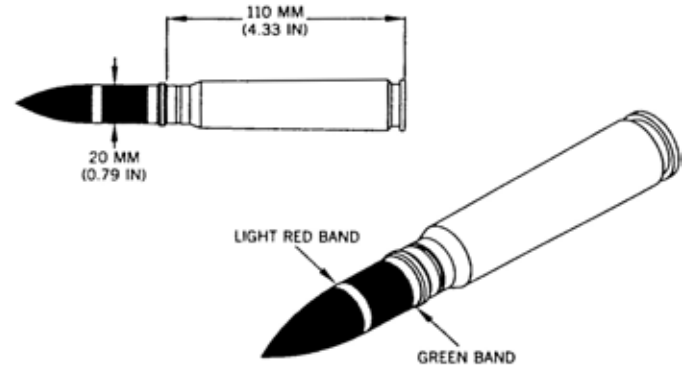

---

## YUGOSLAV PROJECTILE, 20-MM, API, M60

Ordnance used with:  
M60, CARTRIDGE, 20MM X 110MM, API API

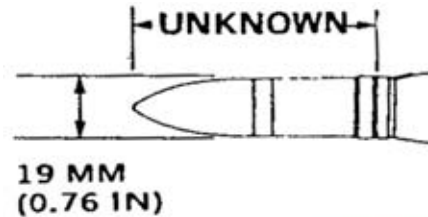

N.E.W. 8.00 G

### U.S.S.R. CARTRIDGE, 23-MM, FRAG-HEI, OFZ

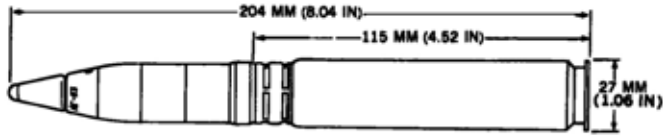

Ordnance used with:  
AG-23, PROJECTILE, PD  
OFZ, 23-MM, FRAG-HEI



---

### U.S.S.R. CARTRIDGE, 23-MM, HEI-T, OFZT



Ordnance used with:  
B-23A, FUZE, PROJECTILE, PD  
OFZT, 23-MM, HEI-T

**GERMAN CARTRIDGE, 20-MM, HVAPDS-T, DM 63**



**COUNTRY UNKNOWN PROJECTILE, SUBCALIBER, TRAINING, MODEL UNKNOWN**

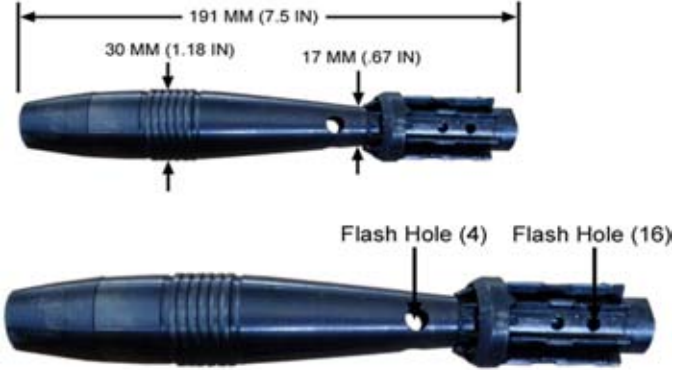

N.E.W. 38.75 G

**CZECHOSLOVOKIAN CARTRIDGE, 30-MM, HEI-T,  
JPSV**

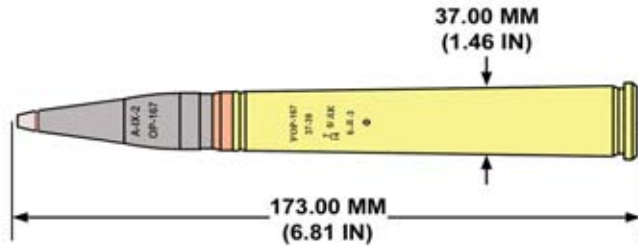

**CZECHOSLOVOKIAN PROJECTILE, 30-MM, HEI-T,  
JFSV**



Ordnance used with:  
M69, 30-MM, HE-T, CARTRIDGE  
CZ-301A, PROJECTILE, PDS  
UT M69 SM, PROJECTILE, PDS  
UNKNOWN, CARTRIDGE, 30-MM, HE

N.E.W. 35.00 G

## RUSSIAN CARTRIDGE, 30-MM, HEI, OFZ

Ordnance used with:  
A-30U, PROJECTILE, PD

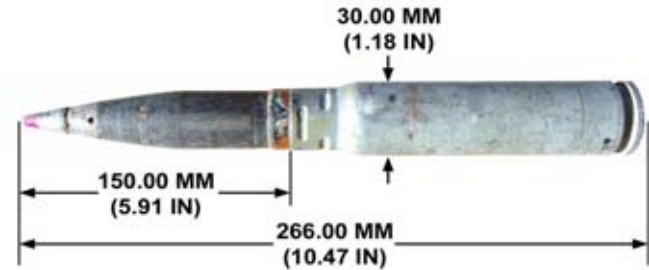

## U.S. CARTRIDGE, 20-MM, HEI, M56A3

Ordnance used with:  
M505A3, PROJECTILE, PDSQ  
M56A3, 20MM, HEI  
M56A4, 20-MM, HEI  
M56E5, 20-MM, HEI  
M103, CARTRIDGE CASE

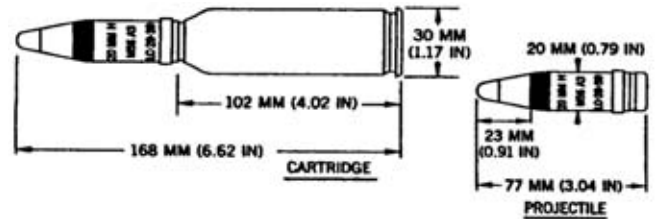

N.E.W. 48.00 G

## U.S.S.R. CARTRIDGE, 30-MM, AP-T, BT-30

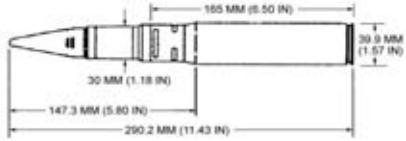

Ordnance used with:  
BT-30, 30MM X 165MM, CARTRIDGE, AP-T

## U.S.S.R. PROJECTILE, 30-MM, FRAG, VOG-17M

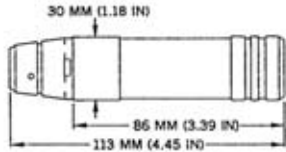

Ordnance used with:  
VMG, PROJECTILE, PD  
7P9M, CARTRIDGE, 30MM, FRAG  
VOG-17M, CARTRIDGE, 30MM, FRAG  
VMG-M, PROJECTILE, PDSD

N.E.W. 33.23 G

## U.S.S.R. PROJECTILE, 30-MM, FRAG, VOG-26

Ordnance used with:  
VOG-26, 30-MM, CARTRIDGE, FRAG  
VMG, PROJECTILE, PD  
VMG-M, PROJECTILE, PDS

N.E.W. 33.00 G

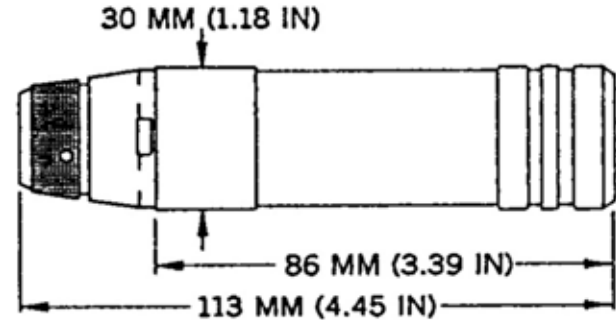

## U.S.S.R. CARTRIDGE, 30-MM, FRAG, VOG-17M

Ordnance used with:  
VMG, PROJECTILE, PD  
VMG-M, PROJECTILE, PDS  
7P9M, 30-MM, FRAGMENTATION  
VOG-17M, 30-MM, FRAGMENTATION

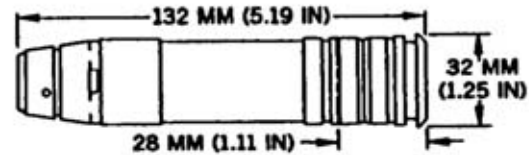

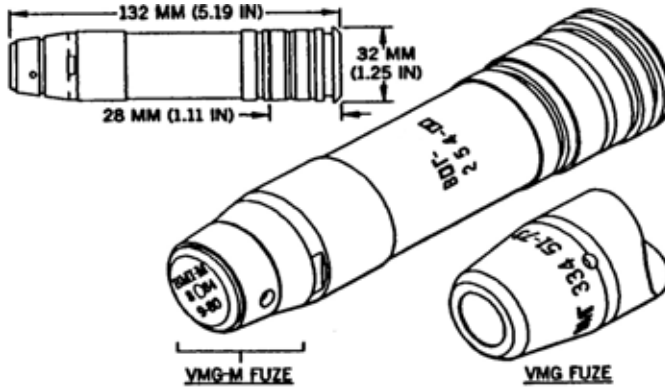

### U.S.S.R. CARTRIDGE, 30-MM, FRAG, VOG-26

Ordnance used with:  
 VMG, PROJECTILE, PD  
 VMG-M, PROJECTILE, PDS  
 VOG-26, 30-MM, FRAGMENTATION

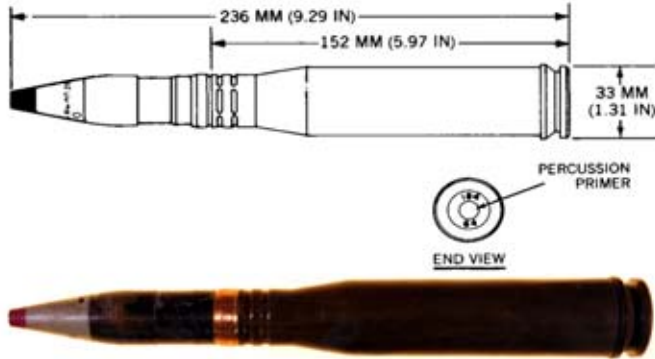

### U.S.S.R. CARTRIDGE, 23-MM, FRAG-HEIT, MODEL OFZT

Ordnance used with:  
 MG-25, FUZE, PROJECTILE, PDS  
 OFZT, 23MM, FRAG-HEIT  
 OFZT, 23-MM, HEI-T  
 ZUR-23-2S, GUN/MISSILE AIR DEFENSE SYSTEM, 23MM, TOWED  
 ZU-23, AIR DEFENSE GUN, 23MM, TWIN, TOWED  
 ZSU-23-4, AIR DEFENSE GUN, 23MM, QUAD, SELF-PROPELLED  
 SKYWIPE, AIR DEFENSE GUN, 23MM, TWIN, TOWED



## U.S.S.R. CARTRIDGE, 23-MM, HEI-FRAG, OFZ

Ordnance used with:  
V-19U, PROJECTILE, PDSD  
OFZ, 23-MM, HEI  
V19UK, PROJECTILE, PDSD  
ZU-23, AIR DEFENSE GUN, 23MM, TWIN, TOWED  
ZSU-23-4, AIR DEFENSE GUN, 23MM, QUAD, SELF-PROPELLED  
SKYWIPE, AIR DEFENSE GUN, 23MM, TWIN, TOWED

N.E.W. 103.00 G

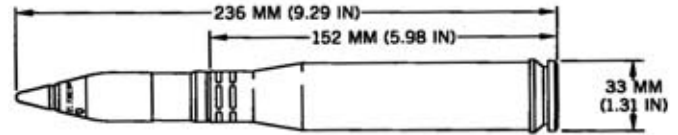

## SWEDISH PROJECTILE, 35-MM, AHEAD, PFHE

Ordnance used with:  
GDF-001, AIR DEFENSE GUN, 35MM, TWIN  
GDF-002, AIR DEFENSE GUN, 35MM, TWIN  
GDF-003, AIR DEFENSE GUN, 35MM, TWIN  
GDF-005, AIR DEFENSE GUN, 35MM, TWIN  
GDM008, 35-MM, NAVAL GUN SYSTEM, MILLENIUM  
AHEAD, 35MM X 228MM, CARTRIDGE, PFHE  
BZD 383, PROJECTILE, ET, BDSD (AHEAD)



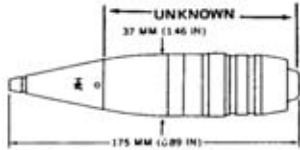

## CHINESE PROJECTILE, 37-MM, FRAG-T, TYPE UNKNOWN



Ordnance used with:

ML-1A

ML1A, PROJECTILE, PD

ML-1, PROJECTILE, PDS

ML1, PROJECTILE, PDS

TYPE 1, PROJECTILE, PDS

TYPE 55, 37MM X 253RMM, CARTRIDGE, HE-T

N.E.W. 50.00 G



## CHINESE PROJECTILE, 37-MM, TYPE 55, AP-T



Ordnance used with:

TYPE 55, CARTRIDGE, 37MM X 253R, AP-T

N.E.W. 13.00 G

## U.S.S.R. CARTRIDGE, 37-MM, AP-T, BZT

Ordnance used with:  
BZT, 37-MM, AP-T



---

## U.S.S.R. CARTRIDGE, 37-MM, FRAG-T, UOR-167

Ordnance used with:  
B-37, PROJECTILE, PDSD  
MG-37, PROJECTILE, PDSD  
MG-8, PROJECTILE, PDSD  
OR-167, 37-MM, FRAG-T

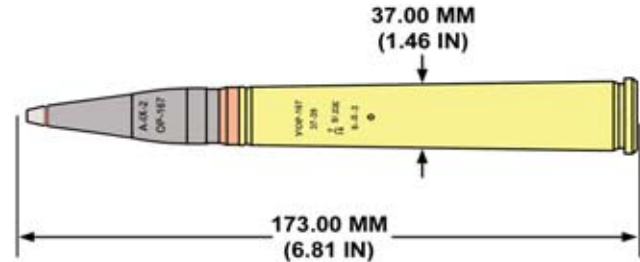

## U.S.S.R. PROJECTILE, 37-MM, AP-T, BR-167

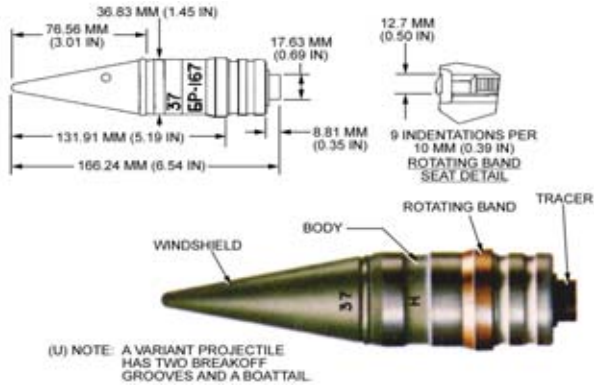

Ordnance used with:  
UBR-167, 37-MM, CARTRIDGE, AP-T (253RMM)

N.E.W. 12.25 G

## U.S.S.R. PROJECTILE, 37-MM, AP-T, TYPE BZT



Ordnance used with:  
BZT, 37MM, CARTRIDGE, AP-T

## U.S.S.R. PROJECTILE, 37-MM, FRAG-T, MODEL OR-167

Ordnance used with:  
B-37, PROJECTILE, PDS  
MG-10, PROJECTILE, PD  
MG-37, PROJECTILE, PDS  
MG-8, PROJECTILE, PDS  
UOR-167, 37-MM, CARTRIDGE, FRAG-T

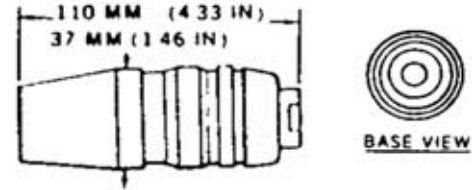

N.E.W. 35.00 G

## U.S.S.R. PROJECTILE, 37-MM, FRAG-T, MODEL OR-167N

Ordnance used with:  
B-37, PROJECTILE, PDS  
MG-37, PROJECTILE, PDS  
MG-8, PROJECTILE, PDS  
UOR-167N, 37-MM X 253RMM, CARTRIDGE, FRAG-T  
UOR-167N, 37-MM, CARTRIDGE, FRAG-T

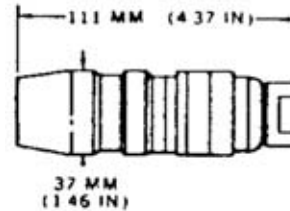

N.E.W. 35.00 G

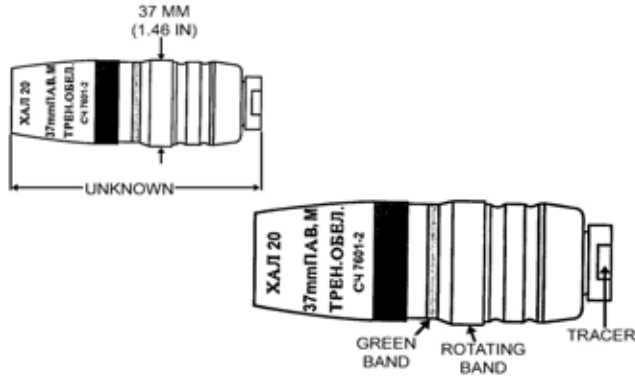

## YUGOSLAV PROJECTILE, 37-MM, HE-T, M39

Ordnance used with:  
UM-8, PROJECTILE, PDS  
A-37U, PROJECTILE, PDS  
B-37, PROJECTILE, PDS  
MG-10, PROJECTILE, PDS  
MG-37, PROJECTILE, PDS  
MG-8, PROJECTILE, PDS  
UM-8, PROJECTILE, PDS  
N.E.W. 35.60 G

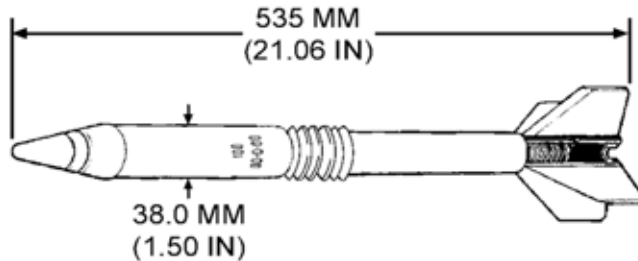

## U.S.S.R. PROJECTILE, 100-MM, APFSDS-T, BM-2 (PENETRATOR)

Ordnance used with:  
UBM-2, CARTRIDGE, 100-MM, APFSDS

## U.S.S.R. PROJECTILE, 100-MM, APFSDS-T, BM-20

Ordnance used with:  
UBM-8, CARTRIDGE, 100-MM, APFSDS

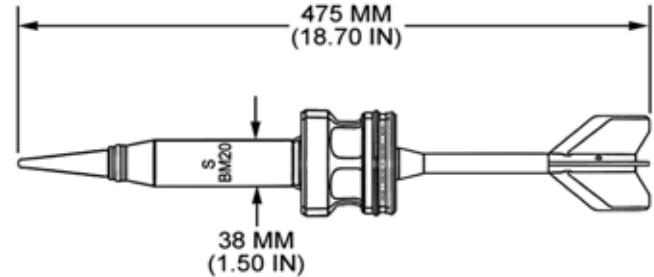

## BULGARIAN GRENADE, 40-MM, HE, MODEL OG-7V

Ordnance used with:  
OG-7V, 40MM, CARTRIDGE, FRAG  
OG-7V, 40MM, HE  
M-6  
M6, PROJECTILE, PD  
O-4M, PROJECTILE, PD  
OG-7VM, CARTRIDGE, 40MM, FRAGMENTATION

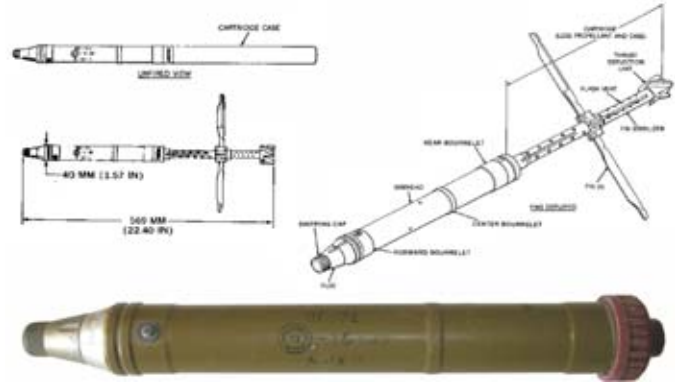

N.E.W. 219.50 G

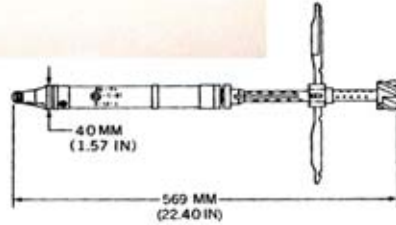

## BULGARIAN GRENADE, 40-MM, HE, MODEL OG-7V

Ordnance used with:  
GO-2, PROJECTILE, PD  
O-4M, PROJECTILE, PD  
OG-7, 40MM, FRAG

N.E.W. 340.50 G

---



## CHINESE PROPELLING CHARGE, PG-2

Ordnance used with:  
PG-2, 80MM, HEAT  
TYPE 56, 80MM, HEAT  
PG-2, 80MM, CARTRIDGE, HEAT  
TYPE 56, 80MM, CARTRIDGE, HEAT

---



**IRAQI PROJECTILE, 40-MM, HE, OG-7**



N.E.W. 210.00 G

**U.S. CARTRIDGE, 40-MM, CLUSTER STAR, XM585**

Ordnance used with:  
XM585, 40-MM, WHITE STAR



N.E.W. 96.00 G

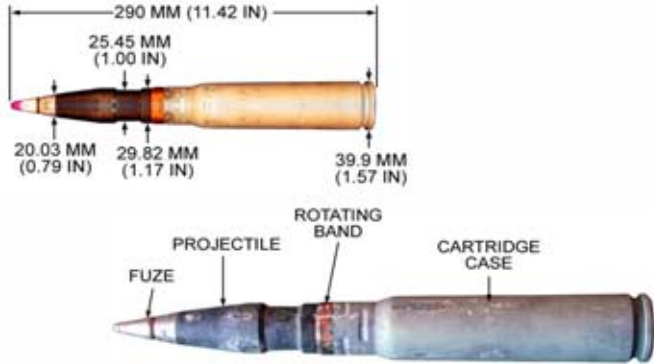

## U.S.S.R. CARTRIDGE, 30-MM, HE-T, OT

Ordnance used with:  
 FT, 30-MM, HE-T  
 OR-84, 30MM, HE-T  
 OT, 30-MM, HE-T  
 OT-30, 30-MM, HE-T  
 A-670M, PROJECTILE, PDS  
 A670M, PROJECTILE, PDS  
 MG-32, PROJECTILE, PDS

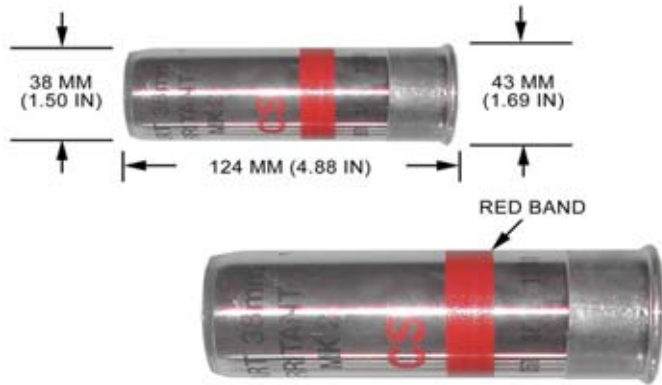

## U.K. CARTRIDGE, 38-MM, RIOT-CONTROL, MK 2

## CZECHOSLOVOKIAN CARTRIDGE, 30-MM, API-T, JPZSV

Ordnance used with:  
M53, AIR DEFENSE GUN, 30MM, TWIN



## U.K. MORTAR, 2-INCH, HE, MODEL UNKNOWN

Ordnance used with:  
NO. 161 MKS 3/2, PD, PROJECTILE  
NO. 161 MK 4, PD, PROJECTILE

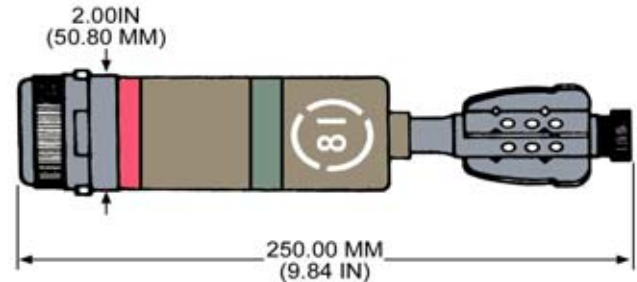



NOTE: BODY MAY BE PAINTED BROWN WITH A 7 MM RED STRIPE ADJACENT TO THE FUZE WELL AND A 12 MM GREEN STRIPE NEAR THE BASE OF THE PROJECTILE.

## U.K. PROJECTILE, 2-INCH, HE, MK 1

Ordnance used with:  
 NO. 161 MKS 3/2, PD, PROJECTILE  
 NO. 161 MK 4, PD, PROJECTILE  
 NO. 162 MK 1/1, PROJECTILE, PD

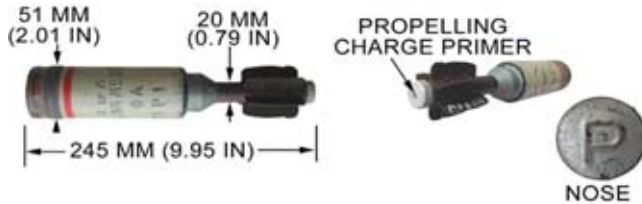

## U.K. PROJECTILE, 2-INCH, ILLUMINATION, MORTAR, MK 2/1

Ordnance used with:  
 MK 1/1, PROPELLING CHARGE

**U.K. PROJECTILE, 2-INCH, MORTAR, SMOKE, MODEL UNKNOWN**

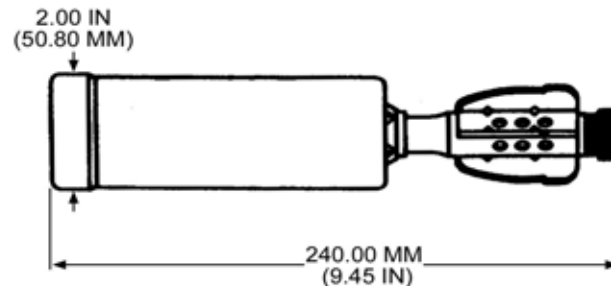

**CHINESE CARTRIDGE, 37-MM, FRAG-T, TYPE 55, HE-T**

Ordnance used with:  
ML-1, PROJECTILE, PDSD  
ML1, PROJECTILE, PDSD  
TYPE 55, 37 MM, HE-T  
TYPE 1, PROJECTILE, PDSD  
TYPE 65, AIR DEFENSE GUN, 37MM, TWIN

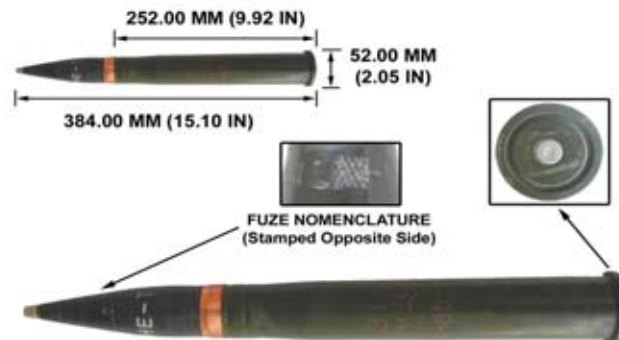



## U.S.S.R. CARTRIDGE, 37-MM, AP-T, UBR-167

Ordnance used with:  
 BR-167, 37-MM, AP-T  
 M1939, AIR DEFENSE GUN, 37MM, TOWED

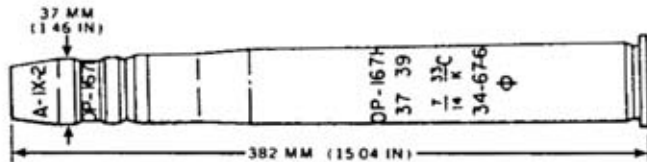

## U.S.S.R. CARTRIDGE, 37-MM, FRAG-T, MODEL OR-167N

Ordnance used with:  
 B-37, PROJECTILE, PDSD  
 MG-37, PROJECTILE, PDSD  
 MG-8, PROJECTILE, PDSD  
 OR-167N, 37-MM, FRAG-T  
 M1939, AIR DEFENSE GUN, 37MM, TOWED



## CHINESE PROJECTILE, 57-MM, HE TYPE UNKNOWN

Ordnance used with:

ML-2

ML-2, PROJOECTILE, PDS

ML2, PROJECTILE, PD

TYPE 1 (ARTILLERY), PROJECTILE, PD

TYPE 3 (SPECIAL) (RECOILLESS RIFLE), PROJECTILE, PD

UNKNOWN, PD

N.E.W. 227.00 G

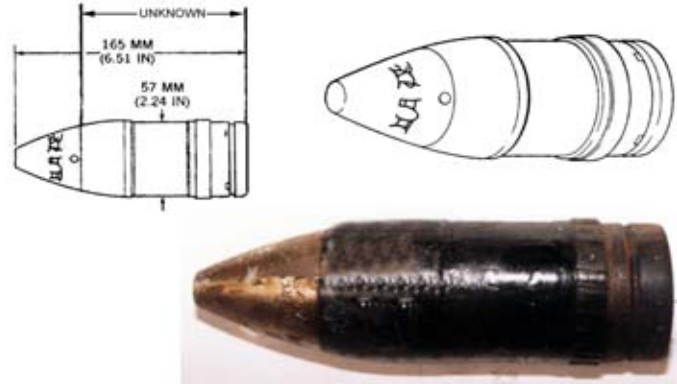

## IRAQI CARTRIDGE, 57-MM, HE, HGC

Ordnance used with:

57-7N, PROJECTILE, PDS

HGC, 57MM, HE

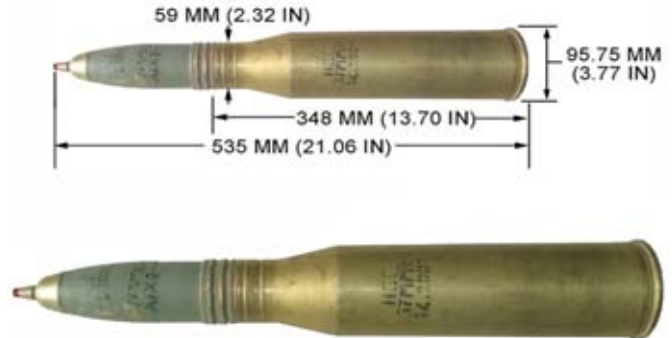

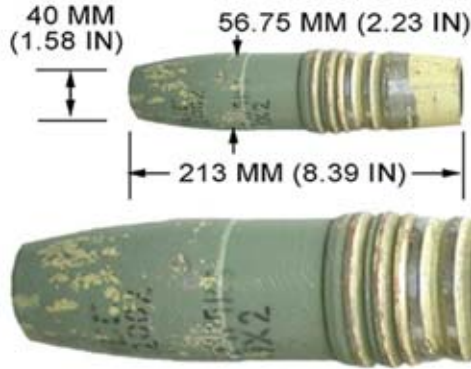

### IRAQI PROJECTILE, 57-MM, HE, HGC

Ordnance used with:  
57-7N, PROJECTILE, PSD  
HGC, 57-MM, CARTRIDGE, HE

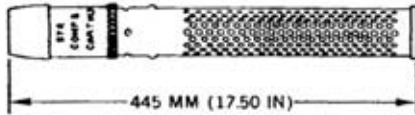

### U.S. CARTRIDGE, 57-MM, HE, M306 & M306A1

Ordnance used with:  
M306, 57-MM, HE  
M306A1, 57-MM, HE, RR  
M503, PROJECTILE, PD  
M503A1, PROJECTILE, PD  
M503A2, PROJECTILE, PD  
M85, PROJECTILE, PD  
M86, PROJECTILE, PD

N.E.W. 19.00 G





## U.S.S.R. CARTRIDGE, 57-MM, FRAG-T, MODEL OR-281U

Ordnance used with:  
MG-57, PROJECTILE, PDS  
53-OR-281U  
OR-281U, 57-MM, FRAG-T  
UOR-281U, 57 MM, FRAG-T  
ZSU-57-2, AIR DEFENSE GUN, 57MM, TWIN  
S-60, AIR DEFENSE GUN, 57MM, TOWED  
57-7N, PROJECTILE, PDS

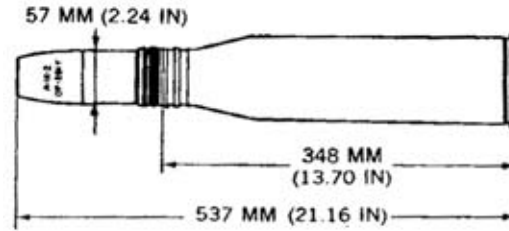

## U.S.S.R. PROJECTILE, 57-MM, APHE-T, BR-281

Ordnance used with:  
UBR-281, 57-MM, CARTRIDGE, APHE-T (57MM X 348MM)  
MD-10, PROJECTILE, BD

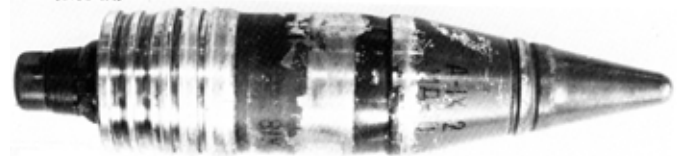
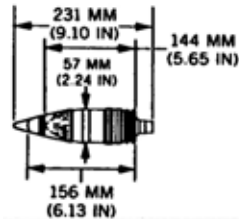

N.E.W. 18.00 G



### U.S.S.R. PROJECTILE, 57-MM, APHE-T, BR-281U

Ordnance used with:  
UBR-281U, 57-MM, CARTRIDGE, APHE-T (57MM X 348MM)  
MD-10, PROJECTILE, BD

N.E.W. 18.00 G

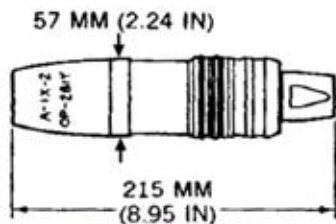

### U.S.S.R. PROJECTILE, 57-MM, FRAG-T, MODEL OR-281U

Ordnance used with:  
MG-57, PROJECTILE, PDS  
MGZ-57, PROJECTILE, PDS  
53-UOR-281U  
UOR-281U, 57 MM, CARTRIDGE  
UOR-281U, CARTRIDGE, 57MM X 348MM, FRAG-T  
57-7N, PROJECTILE, PDS

N.E.W. 154.00 G

## U.S.S.R. PROJECTILE, 57-MM, HE, FRAG-T, MODEL OR-281

Ordnance used with:  
MG-57, PROJECTILE, PSD  
MGZ-57, PROJECTILE, PSD  
UOR-281, CARTRIDGE, 57MM X 348MM, FRAG-T

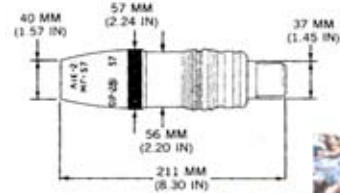

## AUSTRIAN CARTRIDGE, 60-MM, HE, MORTAR, MODEL HE 80

Ordnance used with:  
M525A1, PROJECTILE, PD  
HE 80, 60-MM, HE  
DM 111A3, PROJECTILE, PD  
PDM525, PROJECTILE, PD  
T37A1B1, PROJECTILE, PD  
M525, PROJECTILE, PD  
HE 80, 60-MM, CARTRIDGE, HE, MORTAR  
N.E.W. 200.00 G



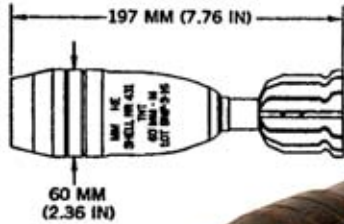

## BELGIAN PROJECTILE, 60-MM, HE, NR431

Ordnance used with:  
 M52A2, FUZE, PROJECTILE, PD  
 DM 111, PROJECTILE, PD  
 NR 2444, PROJECTILE, PD  
 PRB 431, 60-MM, CARTRIDGE, HE/FRAG, MORTAR  
 NR 444, PROJECTILE, PD  
 PRB NR 444, PROJECTILE, PD

N.E.W. 181.00 G

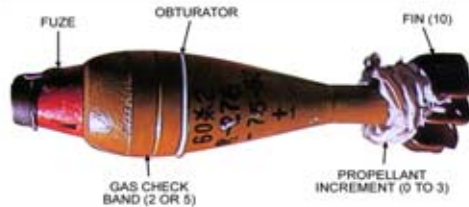
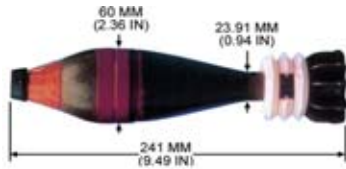

## CHINESE CARTRIDGE, 60-MM, HE, MORTAR, M-83A

Ordnance used with:  
 MP-1B, PROJECTILE, PD  
 MP1B, PROJECTILE, PD  
 83A  
 M-83A, 60 MM, MORTAR, HE  
 M38  
 M83A  
 TYPE 63

## CHINESE CARTRIDGE, 60-MM, MORTAR, SMOKE (WP), TYPE 60-1

Ordnance used with:  
MP-1B, PROJECTILE, PD  
MP1B, PROJECTILE, PD  
M38, PROJECTILE, PD  
MP-1A, PROJECTILE, PD  
MP1A, PROJECTILE, PD  
MP-1, PROJECTILE, PD  
MP1, PROJECTILE, PD

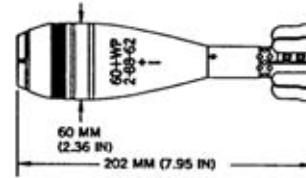

## CHINESE PROJECTILE, 60-MM, HE, MORTAR, M-83A

Ordnance used with:  
MP-1B, PROJECTILE, PD  
MP1B, PROJECTILE, PD  
M38, PROJECTILE, PD  
MP-1A, PROJECTILE, PD  
MP1A, PROJECTILE, PD  
MP-1, PROJECTILE, PD  
MP1, PROJECTILE, PD  
N.E.W. 112.00 G

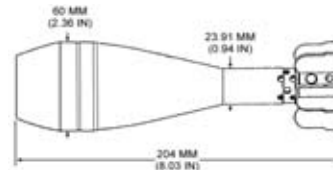

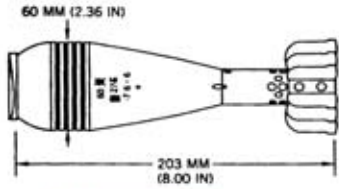

**CHINESE PROJECTILE, 60-MM, HE, MORTAR, TYPE 27**

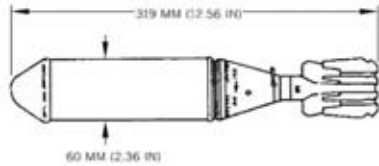

**FRENCH PROJECTILE, 60-MM, ILLUMINATION, MK 63**



Ordnance used with:  
BDMT, MORTAR, PTT



## FRENCH PROJECTILE, 60-MM, SMOKE, MORTAR, M61

Ordnance used with:  
V-19-P, PROJECTILE, PD  
V19P, PROJECTILE, PD  
V9, PROJECTILE, PD  
V19PA, PROJECTILE, PD

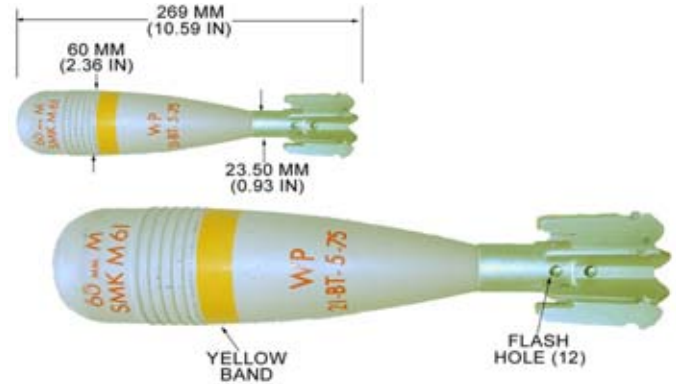

## IRANIAN CARTRIDGE, 60-MM, HE, MORTAR, MODEL UNKNOWN

Ordnance used with:  
DM 111, PROJECTILE, PD  
PDM525, PROJECTILE, PD  
AZ111, PROJECTILE, PD  
DM111, PROJECTILE, PD  
UNKNOWN, 60MM, MORTAR, HE  
UNKNOWN, 60MM, CARTRIDGE, MORTAR, HE



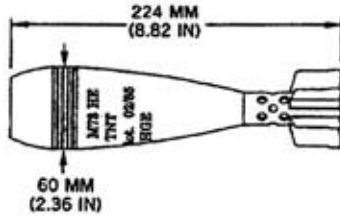

## IRAQI PROJECTILE, 60-MM, HE, M-73

Ordnance used with:  
 UT M70, FUZE, PROJECTILE, PD  
 UT M68 P1, PROJECTILE, PD  
 UT M68P1, PROJECTILE, PD  
 UT.M68 P1, PROJECTILE, PD  
 UT M93, PROJECTILE, PD  
 UT M94, PROJECTILE, PD  
 AZ111, PROJECTILE, PD  
 N.E.W. 257.00 G

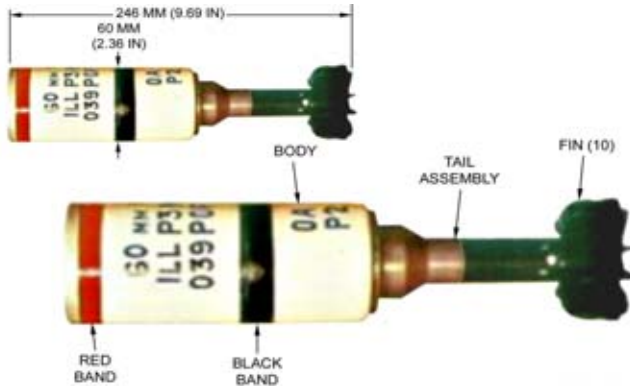

## PAKISTANI PROJECTILE, 60-MM, ILLUMINATION, P3 MK 1

Ordnance used with:  
 P3 MK 1, 60MM, CARTRIDGE, ILLUMINATION, MORTAR



## SINGAPORE PROJECTILE, 60-MM, HE, MODEL

Ordnance used with:  
M111B1, PROJECTILE, PD

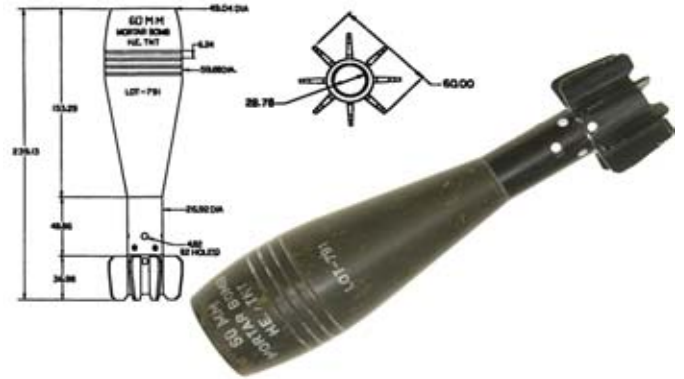

N.E.W. 209.00 G

## SINGAPORE PROJECTILE, 60-MM, MORTAR, HE, MODEL UNKNOWN

Ordnance used with:  
72 (IS72), PROJECTILE, PD  
SP-52, PROJECTILE, PD

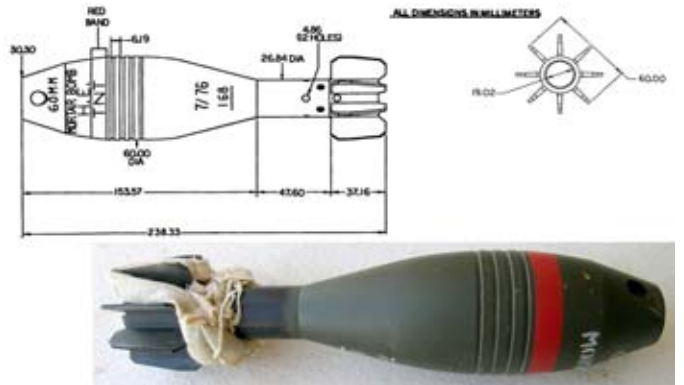

N.E.W. 220.00 G

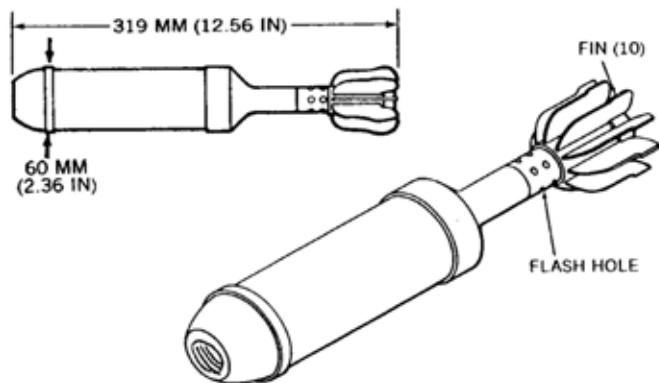

**SPANISH PROJECTILE, 60-MM, MORTAR,  
ILLUMINATION, MODEL UNKNOWN**

Ordnance used with:  
ECIA, PROJECTILE, TIME

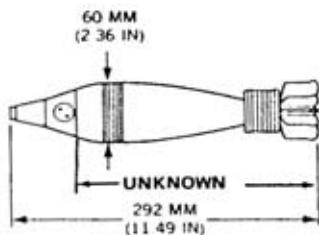

**YUGOSLAV CARTRIDGE, 60-MM, MORTAR, HE,  
MODEL M73**

Ordnance used with:  
M73, 60-MM, HE, MORTAR  
TRM73, 60-MM, HE, MORTAR  
UT M70, FUZE, PROJECTILE, PD  
UT M68 P1, PROJECTILE, PD  
UT M68P1, PROJECTILE, PD  
UT.M68 P1, PROJECTILE, PD  
MU K92, PROJECTILE, PD  
N.E.W. 200.00 G



## YUGOSLAV CARTRIDGE, 60-MM, MORTAR, SMOKE, MODEL 73

Ordnance used with:  
UT M68 P1, PROJECTILE, PD  
UT M68P1, PROJECTILE, PD  
UT.M68 P1, PROJECTILE, PD  
UT M70P1, PROJECTILE, PD  
UT,M70 P1, PROJECTILE, PD

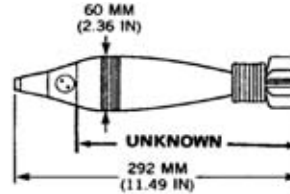

## YUGOSLAV PROJECTILE, 60-MM, HE, MORTAR, MODEL M57

Ordnance used with:  
UTK 55, PROJECTILE, PD  
UT M57, PROJECTILE, PD

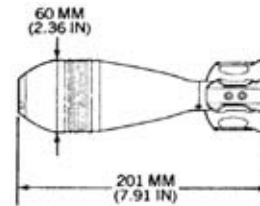

N.E.W. 180.00 G

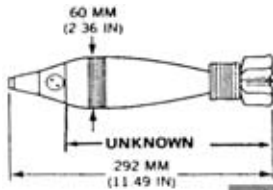

## YUGOSLAV PROJECTILE, 60-MM, HE, MORTAR, MODEL M73

Ordnance used with:

UT M70, FUZE, PROJECTILE, PD  
 UT M68 P1, PROJECTILE, PD  
 UT M68P1, PROJECTILE, PD  
 UT.M68 P1, PROJECTILE, PD  
 UT M93, PROJECTILE, PD  
 UT M94, PROJECTILE, PD  
 AZ111, PROJECTILE, PD

N.E.W. 257.00 G

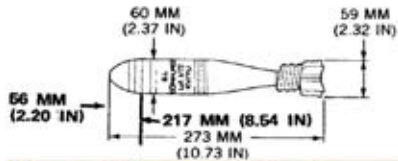

## YUGOSLAV PROJECTILE, 60-MM, ILLUMINATION, MORTAR, M67

Ordnance used with:

M67 PROJECTILE, PTT  
 TP M67, PROJECTILE, PTT

## GERMAN PROJECTILES, 67-MM, HEAT AND APERS (ARMBRUST)

Ordnance used with:  
ARMBRUST, 67MM, CARTRIDGE, HEAT AND APERS

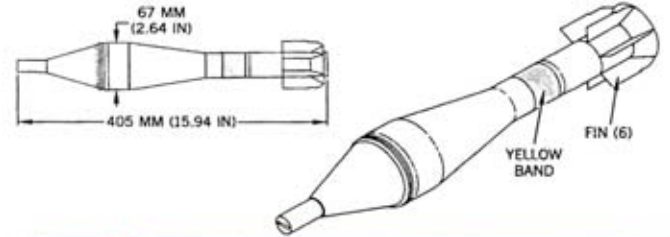

N.E.W. 171.00 G

## BULGARIAN PROJECTILE, 73-MM, HE-FRAG, OG-9B

Ordnance used with:  
GO-2, PROJECTILE, PD  
O-4M, PROJECTILE, PD  
OG-15VB, CARTRIDGE, 73 MM, HE  
SPG-9, 73MM, RECOILESS RIFLE

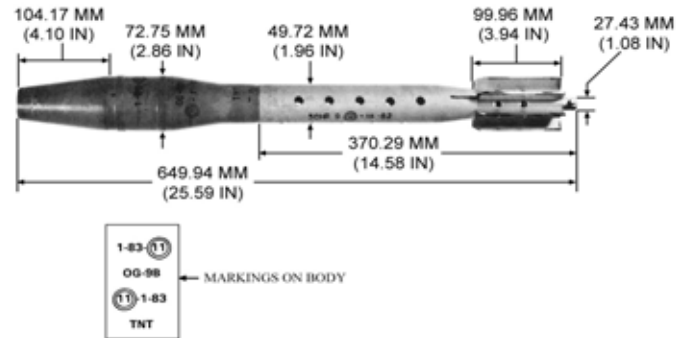

N.E.W. 371.95 G

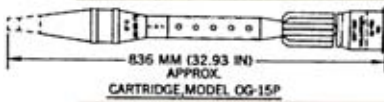
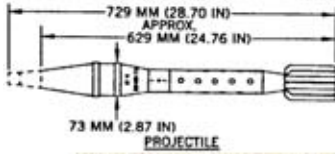

## U.S.S.R. PROJECTILES, 73-MM, HE, FRAG, OG-9 & OG-9M

Ordnance used with:  
 GO-2, PROJECTILE, PD  
 UTIU M85, PROJECTILE, PD  
 O-4M, PROJECTILE, PD  
 OG-9P, 73MM, PROPELLING CHARGE  
 OG-15P, 73-MM, CARTRIDGE, HE  
 SPG-9, 73MM, RECOILESS RIFLE  
 OG-9V, 73MM, CARTRIDGE, FRAG  
 N.E.W. 664.82 G

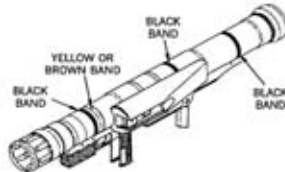
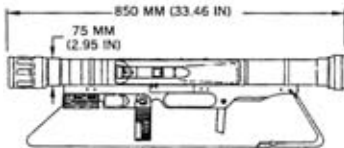

## GERMAN CARTRIDGES, 67-MM, HEAT AND APERS (ARMBRUST)

Ordnance used with:  
 ARMBRUST, 67MM, HEAT  
 ARMBRUST, 67MM, APERS  
 ARMBRUST SC, 67MM, PRACTICE



## U.S. CARTRIDGE, 75 MM, HE, M48

Ordnance used with:  
M48, 75 MM, HE  
M5A1, CARTRIDGE CASE, BRASS  
M5A1B1, CARTRIDGE CASE, STEEL



N.E.W. 1.80 KG

---

## U.S. CARTRIDGE, 75-MM, HE, M41A1

Ordnance used with:  
M41A1, PROJECTILE, 75 MM, HE  
M5A1, CARTRIDGE CASE, BRASS  
M5A1B1, CARTRIDGE CASE, STEEL



N.E.W. 1.80 KG

---

## U.S. PROJECTILE, 75-MM, HE, M41A1



Ordnance used with:  
M48, PROJECTILE, PD  
M501, FUZE, PROJECTILE, MTSQ  
M501A1, FUZE, PROJECTILE, MTSQ  
M502, FUZE, PROJECTILE, MTSQ  
M502A1, FUZE, PROJECTILE, MTSQ  
M518A1, FUZE, PROJECTILE, MTSQ  
M520, FUZE, PROJECTILE, MTSQ

N.E.W. 1.20 LB

---

## U.S. PROJECTILE, 75-MM, HE, M48



Ordnance used with:  
M48, PROJECTILE, PD  
M501, FUZE, PROJECTILE, MTSQ  
M501A1, FUZE, PROJECTILE, MTSQ  
M502, FUZE, PROJECTILE, MTSQ  
M502A1, FUZE, PROJECTILE, MTSQ  
M513 (T226), FUZE, PROJECTILE, VT  
M513A1 (T226E2), FUZE, PROJECTILE, VT

N.E.W. 1.50 LB

---



## U.K. CARTRIDGE, 76-MM, HE, L24A4

Ordnance used with:  
L17A3, PROJECTILE, PD  
L24A4, PROJECTILE, 76 MM, HE

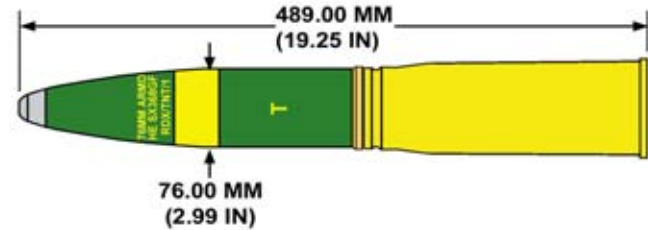

N.E.W. 1.04 KG

## U.K. CARTRIDGE, 76-MM, HEP-T, L29

Ordnance used with:  
L71A1, PROJECTILE, BD  
L29, PROJECTILE, 76 MM, HEP-T  
L29, PROJECTILE, 76 MM, HESH-T

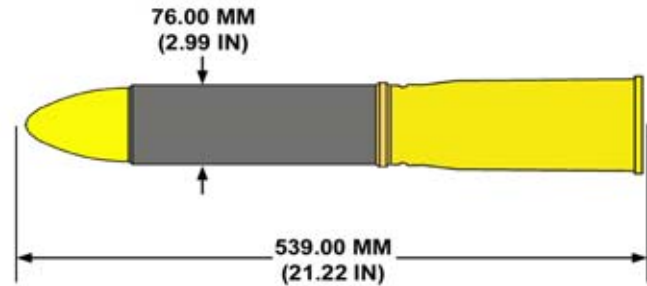

## U.K. CARTRIDGE, 76-MM, SMOKE, HC, L32A5

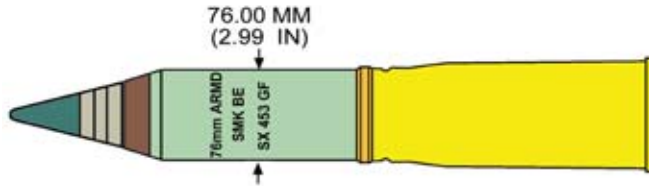

Ordnance used with:  
NO. 221B MK 3, PROJECTILE, TSQ  
NO. 221B MK 4, PROJECTILE, TSQ  
NO. 221B MK 5, PROJECTILE, TSQ  
NO. 221B MK 6, PROJECTILE, TSQ  
NO. 221B MK 7, PROJECTILE, TSQ  
L32A5, PROJECTILE, 76 MM, SMOKE HC



## U.K. PROJECTILE, 3-INCH, SMOKE (WP), MORTAR, MK 4

Ordnance used with:  
NO. 390 MK 2A, PROJECTILE, PTT



## U.K. PROJECTILE, 3-INCH, SMOKE (WP), MORTAR, MK 7

Ordnance used with:

NO. 162 MK 1/2, PROJECTILE, PD

NO. 162 MK 10, PROJECTILE, PD

NO. 162 MK 3, PROJECTILE, PD

NO. 162 MK 3/1, PROJECTILE, PD

NO. 162 MK 3/2, PROJECTILE, PD

NO. 162 MK 3/3, PROJECTILE, PD

NO. 162 MK 4, PROJECTILE, PD



## U.K. PROJECTILE, 76-MM, HE, L24A4

Ordnance used with:

L17A3, PROJECTILE, PD

L24A4, CARTRIDGE, 76 MM, HE

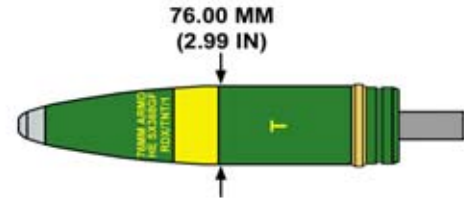

## U.K. PROJECTILE, 76-MM, HEP-T, L29

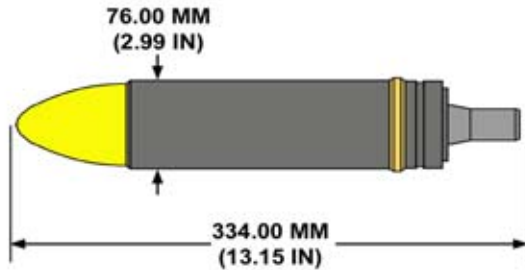

Ordnance used with:  
L71A1, PROJECTILE, BD  
L29, CARTRIDGE, 76 MM, HEP-T  
L29, CARTRIDGE, 76 MM, HESH-T

---

## U.K. PROJECTILE, 76-MM, SMOKE, HC, L32A5

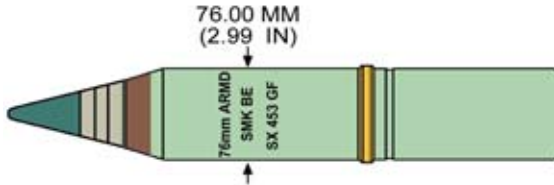

Ordnance used with:  
NO. 221B MK 3, PROJECTILE, TSQ  
NO. 221B MK 4, PROJECTILE, TSQ  
NO. 221B MK 5, PROJECTILE, TSQ  
NO. 221B MK 6, PROJECTILE, TSQ  
NO. 221B MK 7, PROJECTILE, TSQ  
L32A5, CARTRIDGE, 76 MM, SMOKE HC

## U.S.S.R. PROJECTILE, 76-MM, HE, OF-350V

Ordnance used with:  
RGM-2M, PROJECTILE, PD  
UOF-15, 76-MM, CARTRIDGE, HE

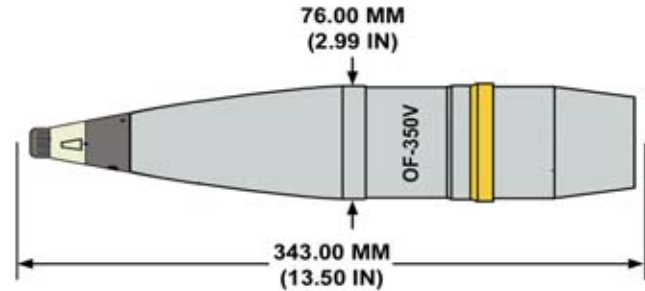

N.E.W. 604.00 G

## U.S.S.R. PROJECTILE, 76-MM, HEAT-FS, MODEL BK-354M

Ordnance used with:  
GPV-2, PROJECTILE, PIBD, SPITBACK

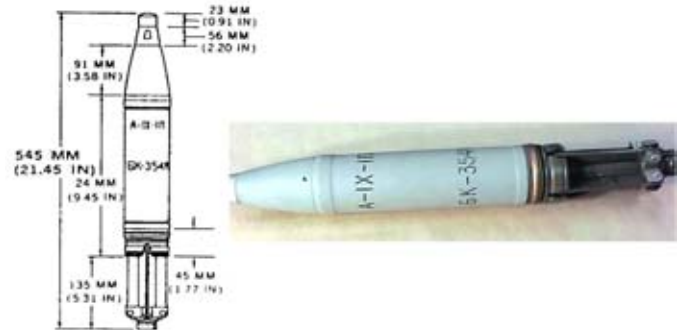

N.E.W. 0.80 KG

## U.S.S.R. PROJECTILE, 76-MM, SMOKE, D-350

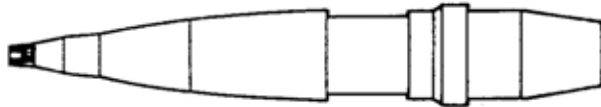
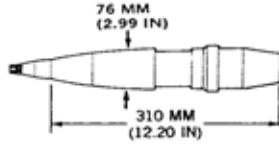

Ordnance used with:  
KT-1, FUZE, PROJECTILE, PD  
KT-2, FUZE, PROJECTILE, PD  
KT-3, FUZE, PROJECTILE, PD  
KTM-1, PROJECTILE, PD  
KTM-1U, PROJECTILE, PD  
KTM-1Y, PROJECTILE, PD  
KTM-2, PROJECTILE, PD

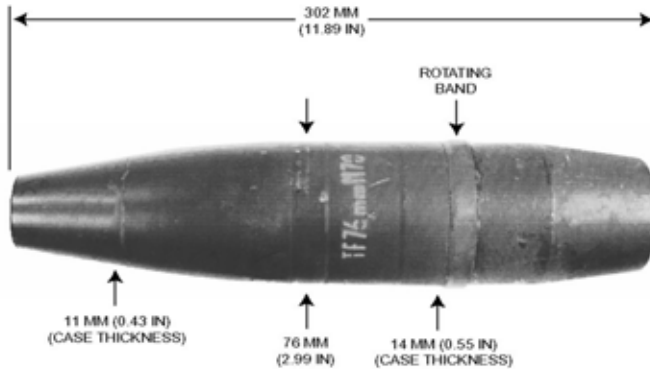

## YUGOSLAV PROJECTILE, 76-MM, HE, M70

Ordnance used with:  
AU-17, PROJECTILE, PD  
UTI M68, PROJECTILE, PD  
AU-18P1, PROJECTILE, PD  
UTIU M72, PROJECTILE, PD  
UTIU M72B1, PROJECTILE, PD  
UTIU M85, PROJECTILE, PD

N.E.W. 600.00 G

## YUGOSLAV PROJECTILE, 76-MM, HE, MODEL M55

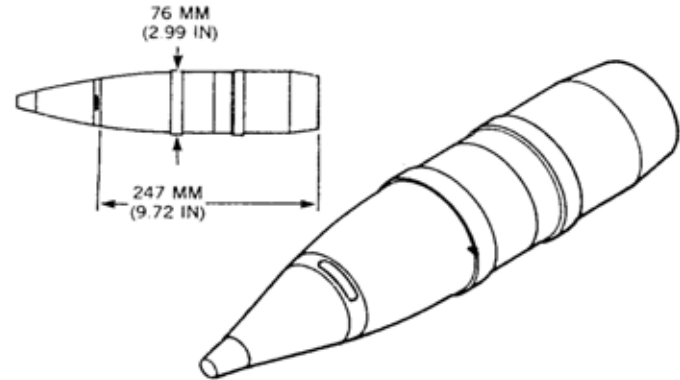

N.E.W. 430.00 G

## U.S.S.R. PROJECTILE, 76-MM, APHEI-T, BZR-350B

Ordnance used with:  
MD-5, PROJECTILE, BD  
MD-6, PROJECTILE, BD  
MD-7, FUZE, PROJECTILE, BD  
MD-8, PROJECTILE, BD  
BZR-350B, 76-MM, CARTRIDGE, APHEI-T

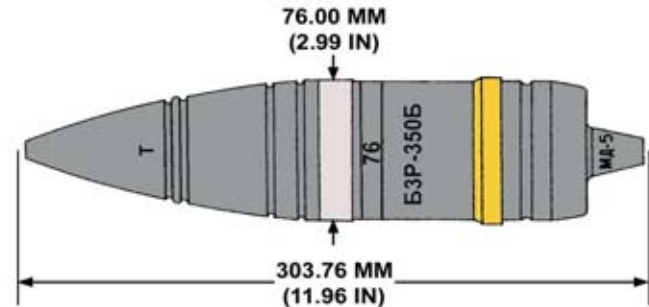

N.E.W. 123.00 G

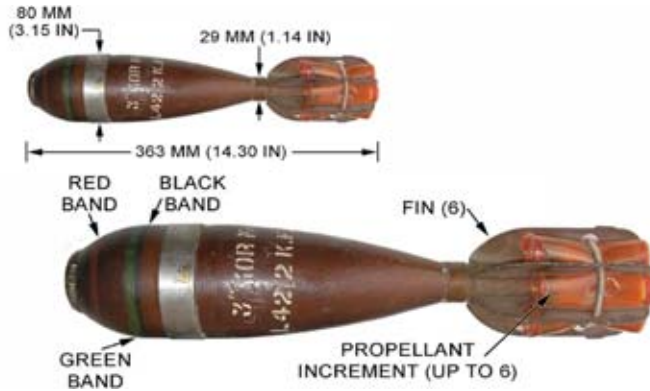

### U.K. PROJECTILE, 3-INCH, HE, MK 3

Ordnance used with:  
 NO. 152 I, PROJECTILE, PD  
 NO. 162 MK 2/1, PROJECTILE, PD

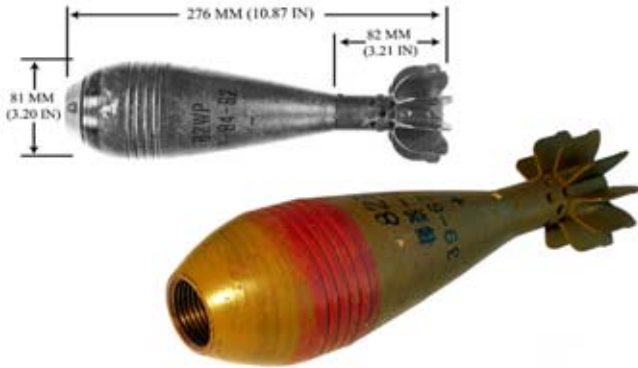

### CHINESE PROJECTILE, 82-MM, SMOKE (WP), MORTAR, TYPE 53

Ordnance used with:  
 M-6  
 M6, PROJECTILE, PD  
 MP-1B, PROJECTILE, PD  
 MP1B, PROJECTILE, PD  
 M38, PROJECTILE, PD  
 MP-1A, PROJECTILE, PD  
 MP1A, PROJECTILE, PD  
 N.E.W. 390.00 G



## FRENCH CARTRIDGE, 81-MM, ILLUMINATION, MORTAR, MK 68

Ordnance used with:  
FH-81B, PROJECTILE, MT  
M68, 81MM, ILLUM  
MK 68, 81MM, ILLUM  
FH-55, PROJECTILE, MT

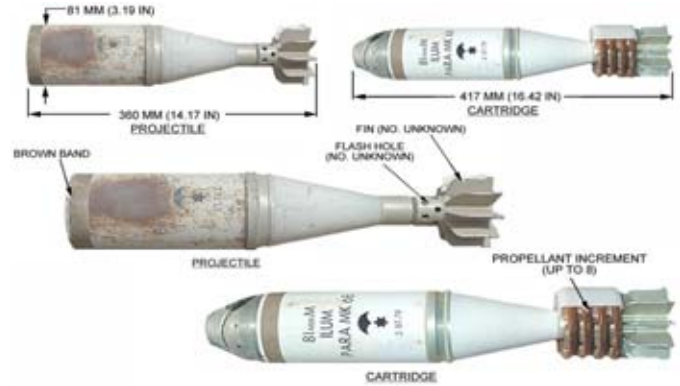

## IRANIAN PROJECTILE, 81-MM, HE, MORTAR, MODEL UNKNOWN

Ordnance used with:  
MP-5C  
MP5C, PROJECTILE, PD  
AZ111 A2, PROJECTILE, PD  
AZ111-A2  
MP-5B, PROJECTILE, PD

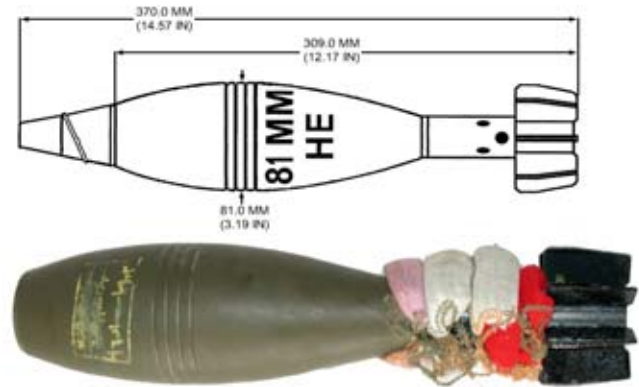

N.E.W. 0.55 KG

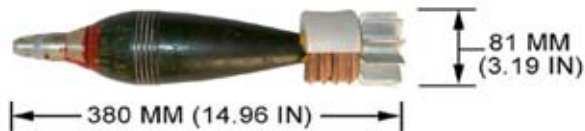

### PAKISTANI CARTRIDGE, 81-MM, HE, MORTAR, M57

Ordnance used with:  
V19PA, PROJECTILE, PD  
M57, 81-MM, MORTAR



### PAKISTANI PROJECTILE, 81-MM, HE, MORTAR, M57

Ordnance used with:  
V19PA, PROJECTILE, PD  
M57, 81-MM, CARTRIDGE, MORTAR



## ROMANIAN PROJECTILE, 82-MM, HE, MORTAR, MODEL O-832

Ordnance used with:  
SH-82, PROJECTILE, PD

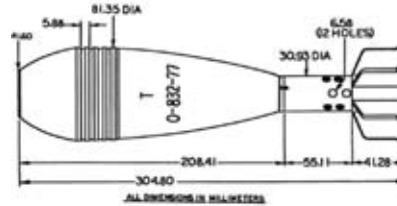

N.E.W. 426.00 G

## SINGAPORE PROJECTILE, 81-MM, MORTAR, HE, MODEL UNKNOWN

Ordnance used with:  
AZ 111 A2  
AZ DM 111A2, PD  
DM 111A2, PROJECTILE, PD  
EF-722 (NOVA), PROJECTILE, PROXIMITY/PD

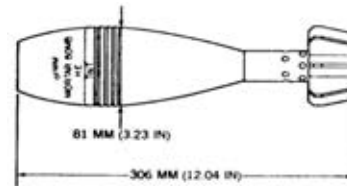

N.E.W. 480.00 G

81 MM  
(3.20 IN)

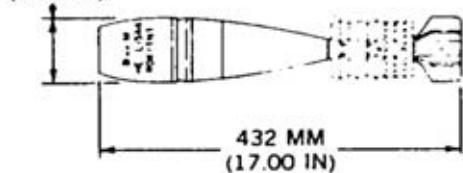

## U.K. PROJECTILE, 81-MM, HE, MODEL L15A1

Ordnance used with:  
L35A1, PROJECTILE, PD  
NO. 162 MK 1/2, PROJECTILE, PD  
NO. 162 MK 10, PROJECTILE, PD  
NO. 162 MK 3, PROJECTILE, PD  
NO. 162 MK 3/1, PROJECTILE, PD  
NO. 162 MK 3/2, PROJECTILE, PD  
NO. 162 MK 3/3, PROJECTILE, PD

81 MM  
(3.19 IN)

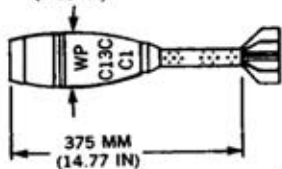

PROPELLANT  
INCREMENT (6)  
FLASH HOLE  
(NO. UNKNOWN)  
FIN (8)

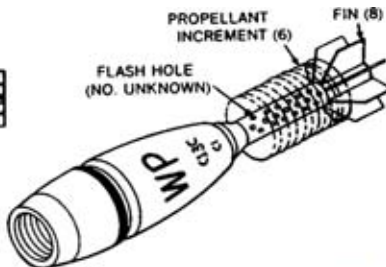

## U.K. PROJECTILE, 81-MM, MORTAR, SMOKE, WP, L19A1

Ordnance used with:  
L35A1, PROJECTILE, PD  
NO. 162 MK 1/2, PROJECTILE, PD  
NO. 162 MK 10, PROJECTILE, PD  
NO. 162 MK 3, PROJECTILE, PD  
NO. 162 MK 3/1, PROJECTILE, PD  
NO. 162 MK 3/2, PROJECTILE, PD  
NO. 162 MK 3/3, PROJECTILE, PD  
N.E.W. 700.00 G



## U.S. PROJECTILE, 81-MM, HE, M43A1B1

Ordnance used with:  
M52, PROJECTILE, PD  
M525A1, PROJECTILE, PD  
M52A1, FUZE, PROJECTILE, PD  
M52A1B1, FUZE, PROJECTILE, PD  
M52A2, FUZE, PROJECTILE, PD  
M52A2B1, FUZE, PROJECTILE, PD  
M52B1, FUZE, PROJECTILE, PD

N.E.W. 600.00 G

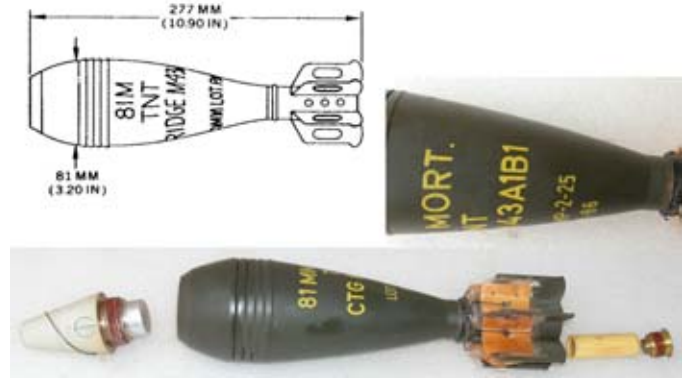

## U.S. PROJECTILE, 81-MM, ILLUMINATION, M853A1

Ordnance used with:  
M768 PROJECTILE, PTT  
M772 PROJECTILE, MTSQ  
M853A1, 81MM, ILLUM

N.E.W. 1.80 LB

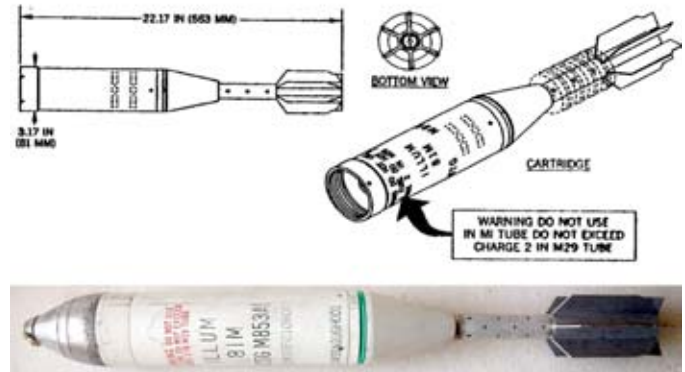

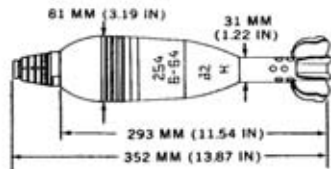

## U.S.S.R. PROJECTILE, 82-MM, ILLUM, MODEL S-832S

Ordnance used with:  
T-1, PROJECTILE, TSQ

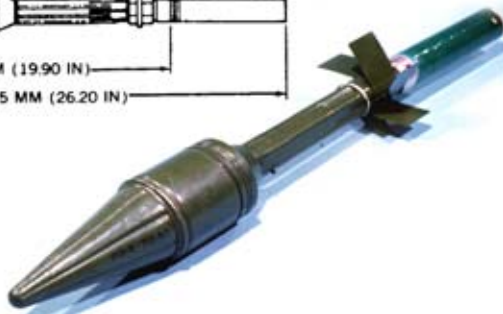
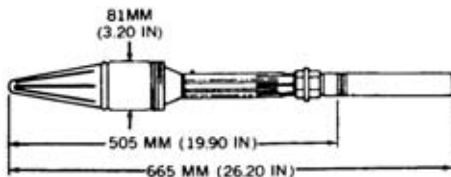

## U.S.S.R. PROJECTILE, HEAT, PG-2; CHINESE PROJECTILE, HEAT, TYPE 56

Ordnance used with:  
PG-2, 80MM, HEAT  
TYPE 56, 80MM, HEAT  
DK-4, PROJECTILE, BD  
DK-2, PROJECTILE, BD  
TYPE 4, PROJECTILE, BD  
PG-2, 80MM, CARTRIDGE, HEAT  
TYPE 56, 80MM, CARTRIDGE, HEAT

## YUGOSLAV CARTRIDGE, 81-MM, MORTAR, ILLUMINATION, M67

Ordnance used with:  
M67 PROJECTILE, PTT  
TP M67, PROJECTILE, PTT  
UTU M67, PROJECTILE, PD

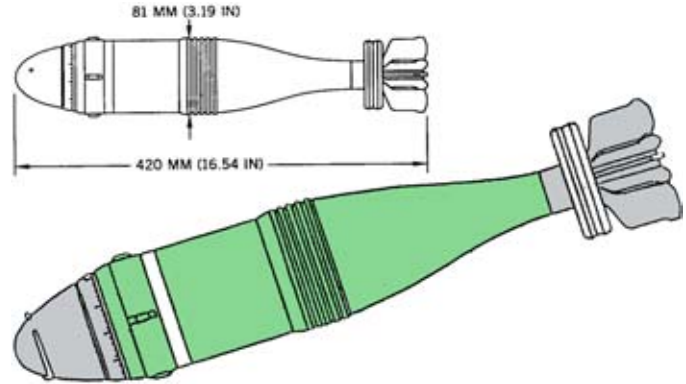

## AUSTRIAN PROJECTILE, 82-MM, HE, MORTAR, HE83 LD

Ordnance used with:  
PDM525, PROJECTILE, PD  
T37A1B1, PROJECTILE, PD  
M52B1, PROJECTILE, PD  
HE 83 LD, CARTRIDGE, 82MM, HE  
TP 70, IGNITER, MORTAR

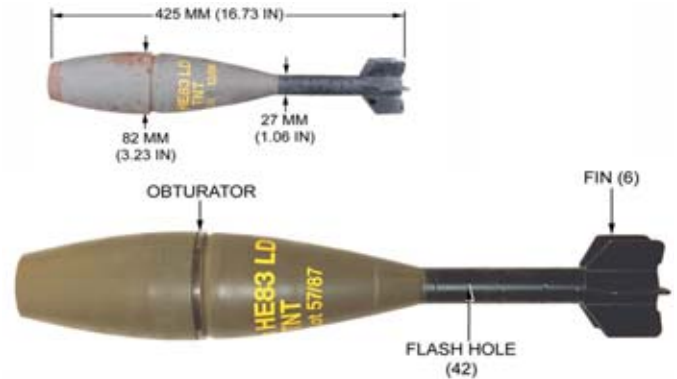

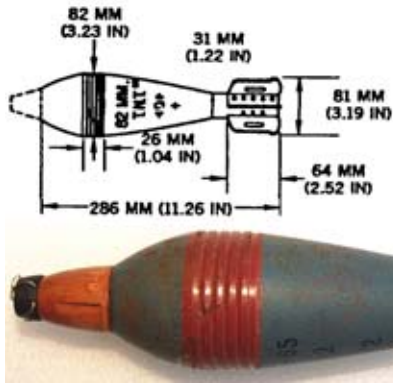

## CHINESE CARTRIDGE, 82-MM, HE, MORTAR, TYPE 53

Ordnance used with:  
 MP-1B, PROJECTILE, PD  
 MP1B, PROJECTILE, PD  
 M38, PROJECTILE, PD  
 MP-1A, PROJECTILE, PD  
 MP1A, PROJECTILE, PD  
 TH521, 82-MM, HE  
 TYPE 53, 82-MM, HE

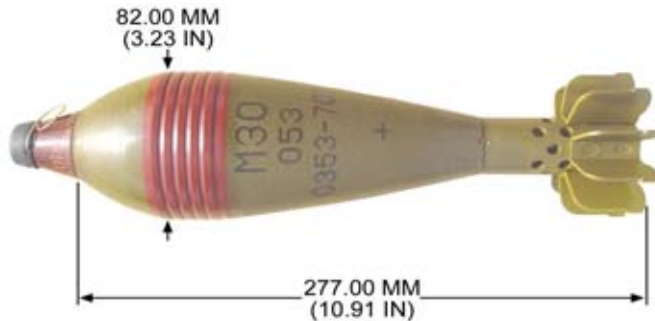

## CHINESE PROJECTILE, 82-MM, HE, MORTAR, M30

Ordnance used with:  
 M-6, PROJECTILE, PD  
 M30P-1  
 TYPE 6, PROJECTILE, PD



## CHINESE PROJECTILE, 82-MM, HE, MORTAR, TYPE 53

Ordnance used with:  
MP-1B, PROJECTILE, PD  
MP1B, PROJECTILE, PD  
M38, PROJECTILE, PD  
MP-1A, PROJECTILE, PD  
MP1A, PROJECTILE, PD  
TYPE UNIVERSAL MODIFIED, PD  
MP-1, PROJECTILE, PD

N.E.W. 0.86 LB

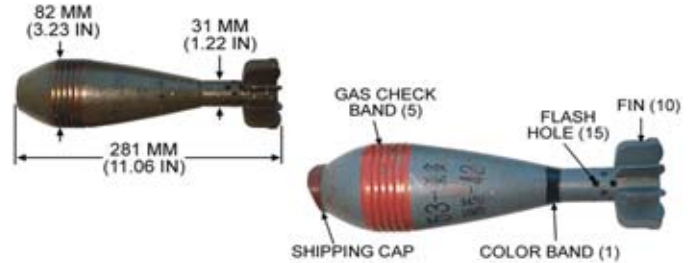

### ALTERNATE COLOR SCHEMES



## CHINESE PROJECTILE, 82-MM, ILLUM, MORTAR, MODEL UNKNOWN

Ordnance used with:  
MS-3A, PROJECTILE, PTT  
SHF-3, PROJECTILE, PTT  
UNKNOWN, 82MM, IGNITION CARTRIDGE, MORTAR

N.E.W. 750.00 G

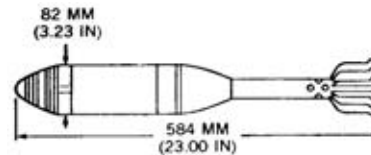

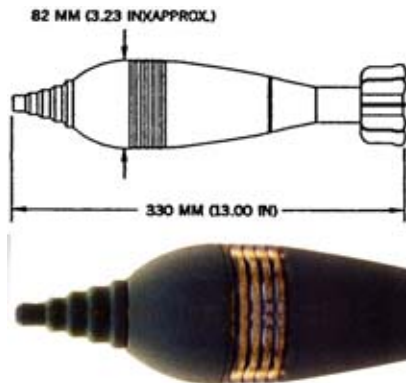

**HUNGARIAN PROJECTILE, 82-MM, MORTAR, HEAT, MODEL UNKNOWN (BEKM-82)**

---

**NORTH KOREAN CARTRIDGE, 82-MM, FRAG, O-881**



Ordnance used with:  
GK-1, FUZE, PROJECTILE, PD  
O-881, 82 MM, FRAG  
B-2, PROJECTILE, PD

## NORTH KOREAN PROJECTILE, 82-MM, FRAG, 0-881

Ordnance used with:  
GK-2, FUZE, PROJECTILE, PD  
O-881, CARTRIDGE, 82MM, FRAGMENTATION  
B-2, PROJECTILE, PD

N.E.W. 470.00 G

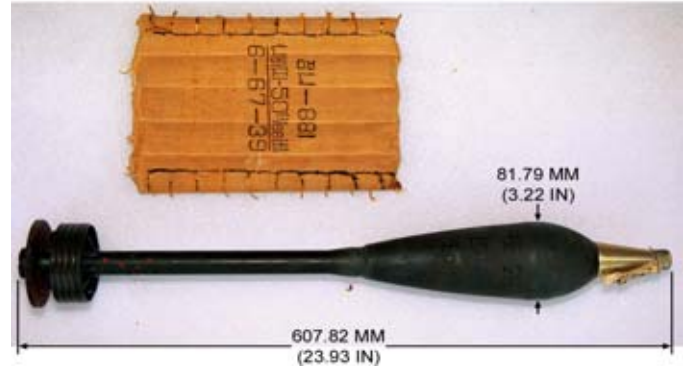

## POLISH PROJECTILE, 82-MM, HEAT, BK-881

Ordnance used with:  
GK-2, FUZE, PROJECTILE, PD

N.E.W. 460.00 G

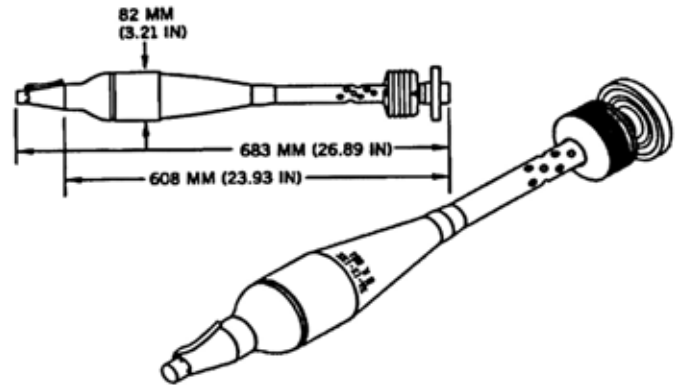

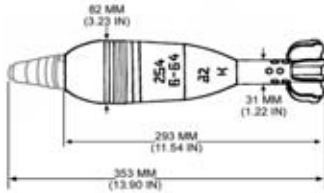

**ROMANIAN PROJECTILE, 82-MM, ILLUMINATION, MORTAR, MODEL UNKNOWN**

Ordnance used with:  
 T-1, PROJECTILE, TSQ  
 UNKNOWN, 82MM, CARTRIDGE, ILLUMINATION



N.E.W. 692.50 G

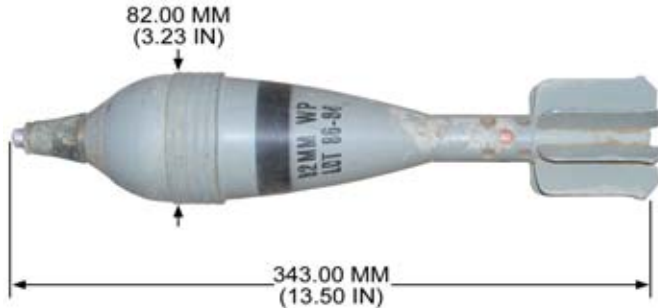

**SPANISH PROJECTILE, 82-MM, MORTAR, WP, SMOKE, MODEL UNKNOWN**

## U.S.S.R. CARTRIDGE, 82-MM, RECOILLESS, BK-881

Ordnance used with:  
GK-1, FUZE, PROJECTILE, PD  
GK-2, FUZE, PROJECTILE, PD  
GK-2M, FUZE, PROJECTILE, PD

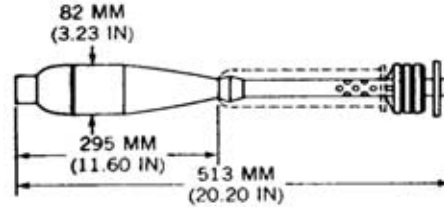

N.E.W. 1.36 KG

## U.S.S.R. CARTRIDGE, 82-MM, RECOILLESS, HEAT, BK-881M

Ordnance used with:  
GK-2, FUZE, PROJECTILE, PD  
GK-2M, FUZE, PROJECTILE, PD  
ZHN-881, 82MM, PROPELLING CHARGE

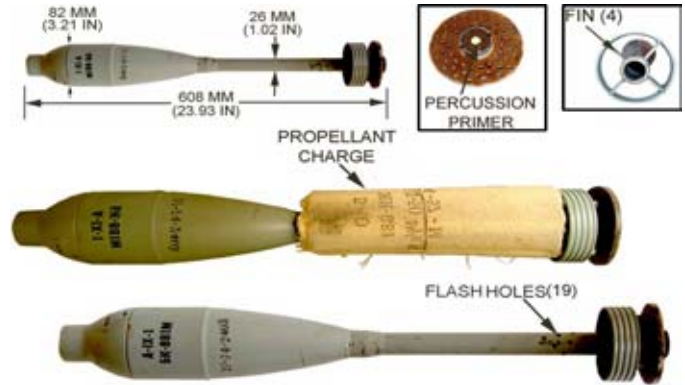

N.E.W. 1.36 KG



### U.S.S.R. CARTRIDGE, 82-MM, RECOILLESS, PRACTICE, PBK-881

Ordnance used with:  
GK-2, PROJECTILE, DUMMY  
ZHN-881, 82MM, PROPELLING CHARGE

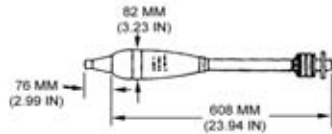

### U.S.S.R. PROJECTILE, 82-MM, FRAG, RECOILLESS-RIFLE, MODEL 0-881A

Ordnance used with:  
GK-2, FUZE, PROJECTILE, PD



N.E.W. 470.00 G

**U.S.S.R. PROJECTILE, 82-MM, MORTAR, FRAG,  
MODEL 0-832-DU**

Ordnance used with:  
SH-82, PROJECTILE, PD  
M-1, PROJECTILE, PDSQ  
TYPE 1, PROJECTILE, PD  
M-2, PROJECTILE, PD  
M-3, PROJECTILE, PD  
M-4, PROJECTILE, PD  
M-5, PROJECTILE, PD

N.E.W. 0.44 KG

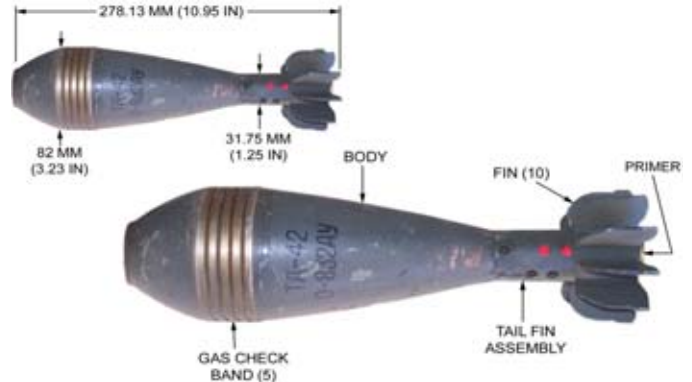

**U.S.S.R. PROJECTILE, 82-MM, MORTAR, FRAG,  
MODEL 0-832D**

Ordnance used with:  
SH-82, PROJECTILE, PD  
M-1, PROJECTILE, PDSQ  
TYPE 1, PROJECTILE, PD  
M-2, PROJECTILE, PD  
M-3, PROJECTILE, PD  
M-4, PROJECTILE, PD  
M-5, PROJECTILE, PD

N.E.W. 0.41 KG

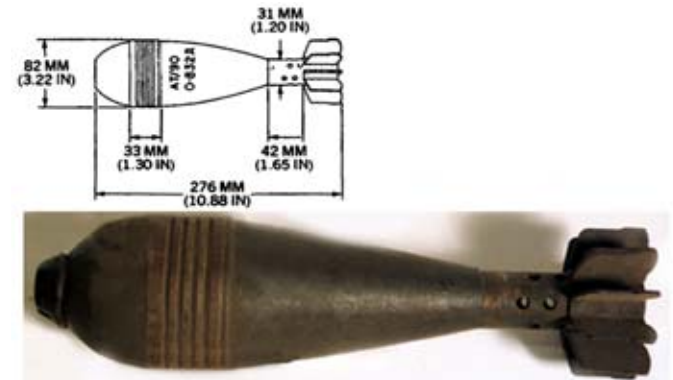

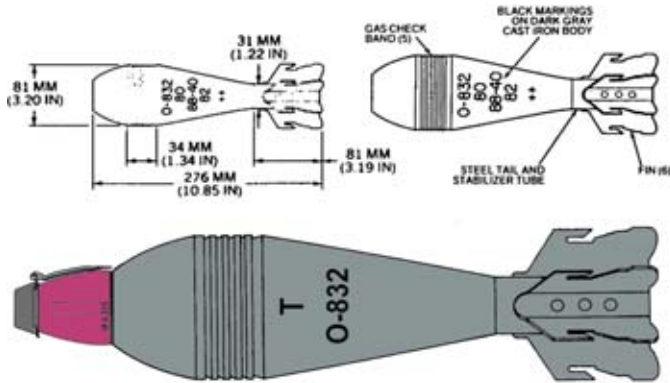

**U.S.S.R. PROJECTILE, 82-MM, MORTAR, FRAG, MODEL O-832**

Ordnance used with:  
 M-1, PROJECTILE, PDSQ  
 TYPE 1, PROJECTILE, PD  
 M-2, PROJECTILE, PD  
 M-3, PROJECTILE, PD  
 M-4, PROJECTILE, PD  
 M-5, PROJECTILE, PD  
 M-6, PROJECTILE, PD  
 N.E.W. 430.00 G

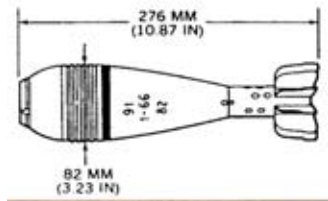

**U.S.S.R. PROJECTILE, 82-MM, MORTAR, SMOKE, WP, MODEL D-832DU**

Ordnance used with:  
 SH-82, PROJECTILE, PD  
 M-5, PROJECTILE, PD  
 M-6, PROJECTILE, PD  
 M-5M, PROJECTILE, PD  
 M-5A  
 M-5A, PD, PROJECTILE





## U.S.S.R. PROJECTILE, 82-MM, PROPELLING CHARGE, ZHN-881

Ordnance used with:  
BK-881M, 82-MM, CARTRIDGE, HEAT  
PBK-881, 82-MM, CARTRIDGE, PRACTICE



N.E.W. 821.00 G

---

## YUGOSLAV CARTRIDGE, 82-MM, HE, MORTAR, M74

Ordnance used with:  
UT M68 P1, PROJECTILE, PD  
UT M68P1, PROJECTILE, PD  
UT.M68 P1, PROJECTILE, PD  
M74, 82MM, HE, MORTAR  
M6-R, PROJECTILE, PD  
M-6R, PROJECTILE, PD

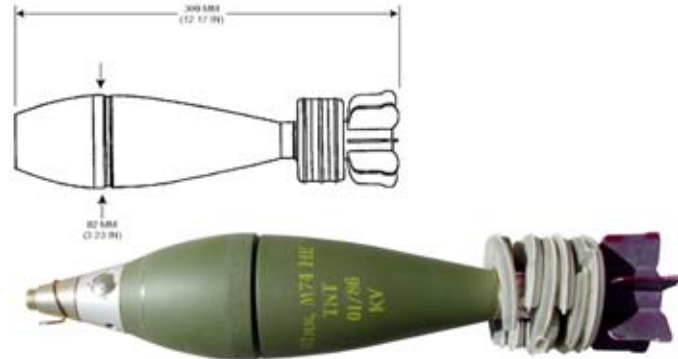

N.E.W. 680.00 G

---

## YUGOSLAV CARTRIDGE, 82-MM, MORTAR, HE, M31

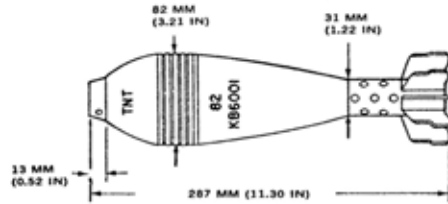

Ordnance used with:  
UT M45 P1, PROJECTILE, MORTAR, PD



N.E.W. 1.02 KG

---

## YUGOSLAV CARTRIDGE, 82-MM, MORTAR, SMOKE, MODEL M74

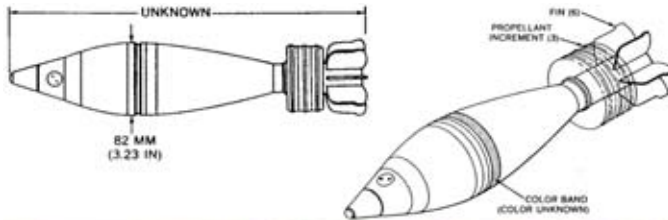

Ordnance used with:  
UT M70P1, PROJECTILE, PD  
UT, M70 P1, PROJECTILE, PD  
UTU M67, PROJECTILE, PD  
M74, 82MM, SMOKE, WP, MORTAR



## YUGOSLAV PROJECTILE, 82-MM, HE, MORTAR, M68P1

Ordnance used with:  
UT M68 P1, PROJECTILE, PD  
UT M68P1, PROJECTILE, PD  
UT.M68 P1, PROJECTILE, PD  
UT M93, PROJECTILE, PD  
UTU M67, PROJECTILE, PD  
UT M5P1, PROJECTILE, PD  
UTM5P1, PROJECTILE, PD

N.E.W. 530.00 G

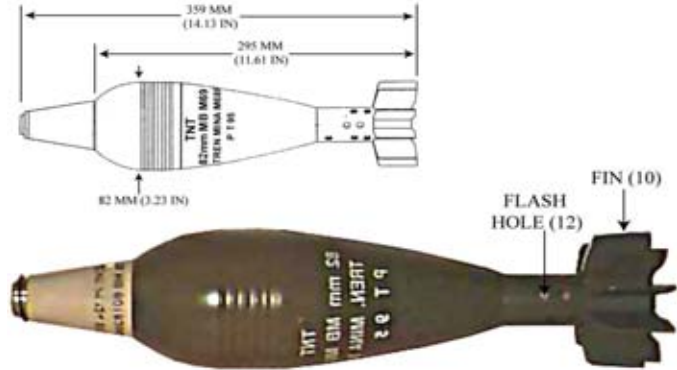

## YUGOSLAV PROJECTILE, 82-MM, HE, MORTAR, MODEL M71

Ordnance used with:  
UT M68 P1, PROJECTILE, PD  
UT M68P1, PROJECTILE, PD  
UT.M68 P1, PROJECTILE, PD  
UTU M67, PROJECTILE, PD  
M71, 82-MM, HE, MORTAR  
UT M5P1, PROJECTILE, PD  
UTM5P1, PROJECTILE, PD

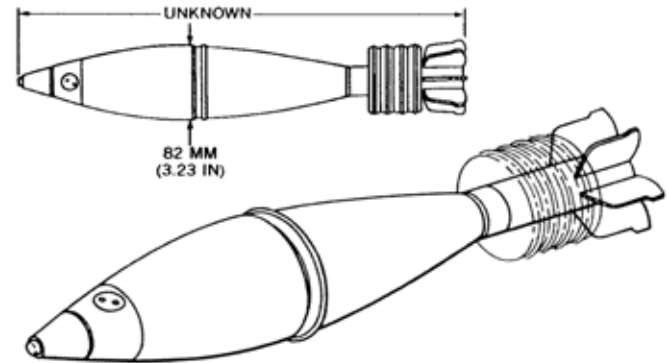

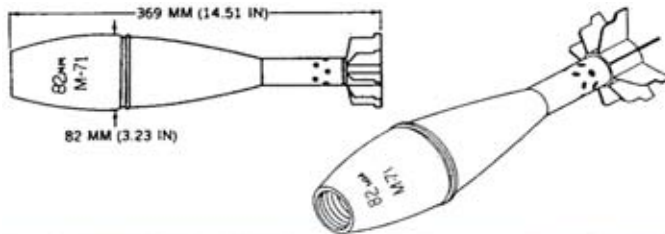

### YUGOSLAV PROJECTILE, 82-MM, HE, MORTAR, MODEL M71

Ordnance used with:  
 UT M68 P1, PROJECTILE, PD  
 UT M68P1, PROJECTILE, PD  
 UT.M68 P1, PROJECTILE, PD  
 UTU M67, PROJECTILE, PD  
 UT M5P1, PROJECTILE, PD  
 UTM5P1, PROJECTILE, PD  
 M71, 82MM, CARTRIDGE, HE, MORTAR

N.E.W. 690.00 G



### YUGOSLAV PROJECTILE, 82-MM, SMOKE, MORTAR, MODEL M74

Ordnance used with:  
 UT M70P1, PROJECTILE, PD  
 UT,M70 P1, PROJECTILE, PD  
 UTU M67, PROJECTILE, PD  
 M74, 82MM, CARTRIDGE, SMOKE, WP, MORTAR



**SWEDISH CARTRIDGE, 84-MM, APERS, FFV 64D;  
L43A1**

Ordnance used with:  
FFV 64C, PROJECTILE, PI  
FFV 64D, 84-MM, APERS  
L43A1, 84MM, APERS

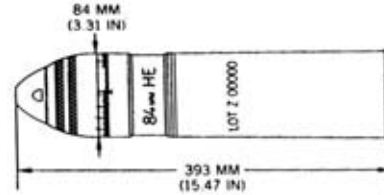

**SWEDISH CARTRIDGE, 84-MM, HEAT, MODEL AT-4**

Ordnance used with:  
AT-4, 84MM, HEAT  
M136  
MODEL UNKNOWN, LAUNCHER, AT-4  
N8T, DETONATOR, ELECTRIC

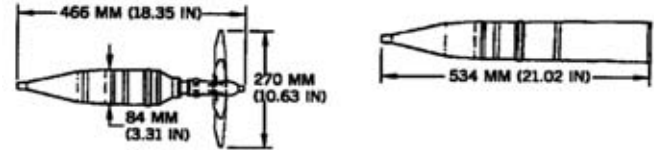

N.E.W. 381.00 G

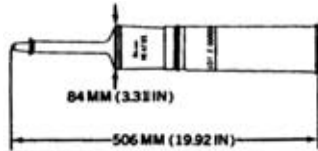

## SWEDISH CARTRIDGE, 84-MM, HEAT-T, FFV 65

Ordnance used with:  
F/551

FFV-551, PROJECTILE, PIBD

M/66, PROJECTILE, PIBD

FFV 65, 84-MM, HEAT-T

C14, 84MM, SYSTEM, AT, OFF ROUTE

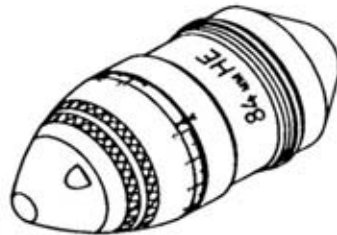
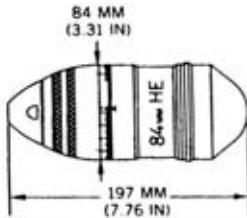

## SWEDISH PROJECTILE, 84-MM, APERS, FFV 64D; L43A1

Ordnance used with:

FFV 64D, 84-MM, CARTRIDGE, APERS

L43A1, 84MM, CARTRIDGE, APERS

FFV 64C, PROJECTILE, PI

N.E.W. 400.00 G

## SWEDISH PROJECTILE, 84-MM, HEAT, MODEL AT-4

Ordnance used with:  
AT-4, CARTRIDGE, 84-MM HEAT  
M136  
N8T, DETONATOR, ELECTRIC

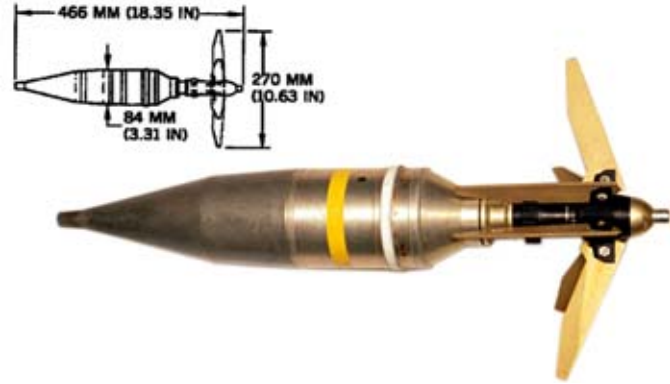

N.E.W. 460.00 G

## SWEDISH PROJECTILE, 84-MM, HEAT-T, FFV 65

Ordnance used with:  
FFV 65 CARTRIDGE, 84-MM, HEAT-T  
F/551  
FFV-551, PROJECTILE, PIBD  
M/66, PROJECTILE, PIBD



N.E.W. 500.00 G

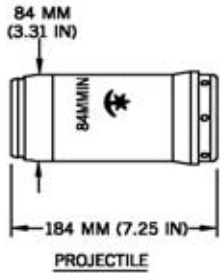

**SWEDISH PROJECTILE, 84-MM, ILLUMINATION, FFV 545**

Ordnance used with:  
FFV 545, 84 MM, CARTRIDGE, ILLUMINATING  
UNKNOWN, PTT

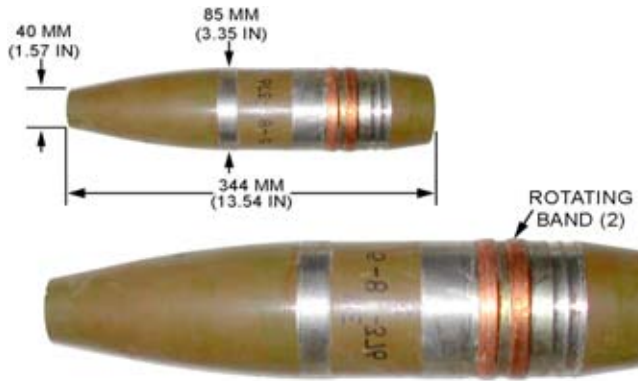

**CHINESE PROJECTILE, 85-MM, HE, MODEL UNKNOWN**

Ordnance used with:  
ML-5  
ML5, PROJECTILE, PD  
MODEL UNKNOWN, 85-MM, CARTRIDGE, HE



## CHINESE PROJECTILE, 85-MM, HEAT, TYPE 56

Ordnance used with:  
PROJECTILE, PIBD-L, UNDESIGNATED

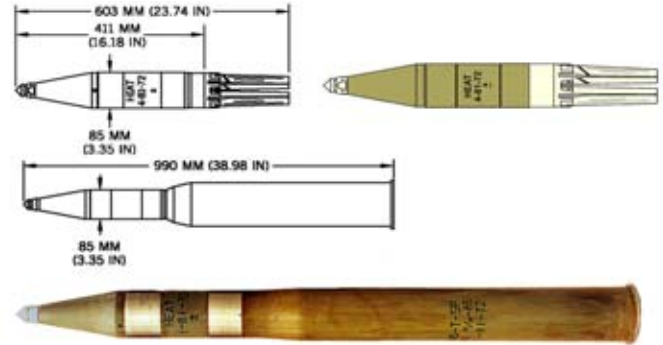

N.E.W. 632.00 G

## CHINESE ROCKET, 85-MM, HEAT, TYPE 84

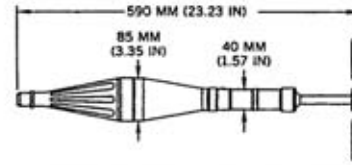

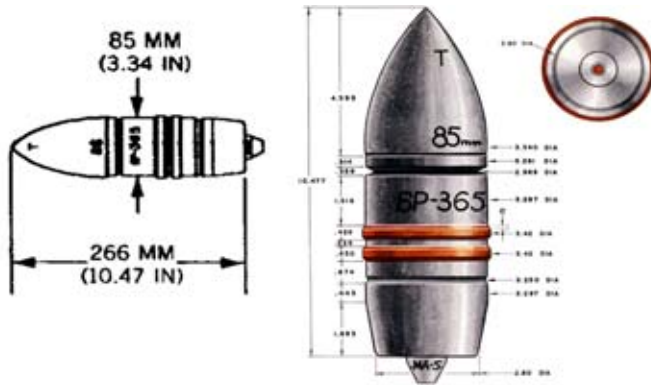

## U.S.S.R. PROJECTILE, 85-MM, APHE-T, BR-365

Ordnance used with:  
 UBR-365, CARTRIDGE, 85-MM, APHE-T  
 MD-10, PROJECTILE, BD  
 MD-5, PROJECTILE, BD  
 MD-7, FUZE, PROJECTILE, BD  
 MD-8, PROJECTILE, BD

N.E.W. 68.00 G

## U.S.S.R. PROJECTILE, 85-MM, APHE-T, BR-365K

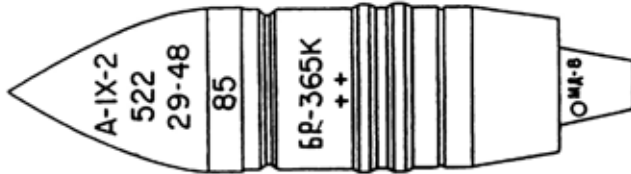

Ordnance used with:  
 UBR-365K, 85-MM, CARTRIDGE, APHE-T  
 MD-10, PROJECTILE, BD  
 MD-7, FUZE, PROJECTILE, BD  
 MD-8, PROJECTILE, BD

## U.S.S.R. PROJECTILE, 85-MM, APHE-T, BR-367

Ordnance used with:  
TYPE 367, 85-MM, CARTRIDGE, APHE-T  
UBR-367, 85-MM, CARTRIDGE, APHE-T  
DBR-2, PROJECTILE, BD  
MD-8, PROJECTILE, BD

N.E.W. 127.00 G

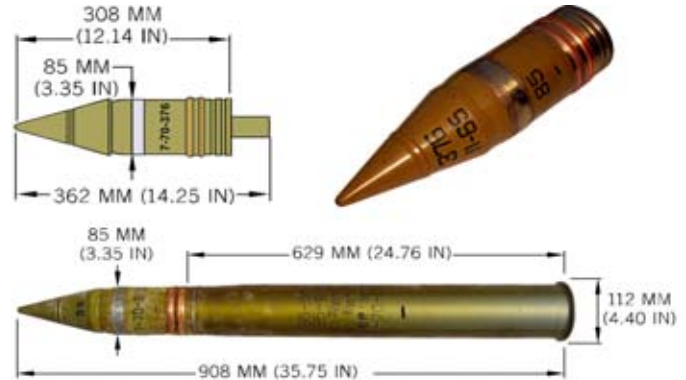

## U.S.S.R. PROJECTILE, 85-MM, FIXED, FRAG, MODEL 0-365K

Ordnance used with:  
NSC-1, PROJECTILE, PDSD  
KTM-1, PROJECTILE, PD  
KTM-1U, PROJECTILE, PD  
KTM-1Y, PROJECTILE, PD  
KTM-2, PROJECTILE, PD  
KTM-3, PROJECTILE, PD  
KTM3-1, PROJECTILE, PD

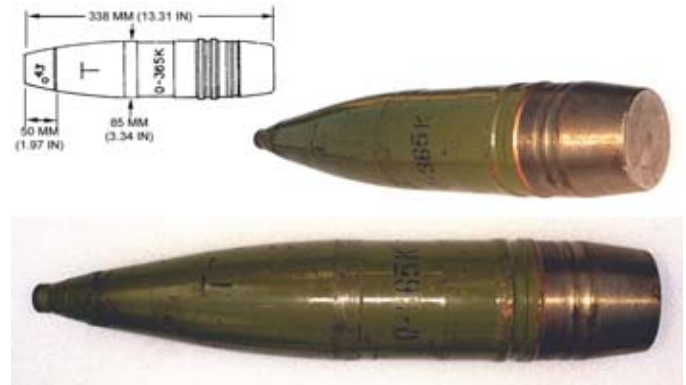

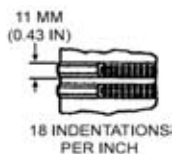
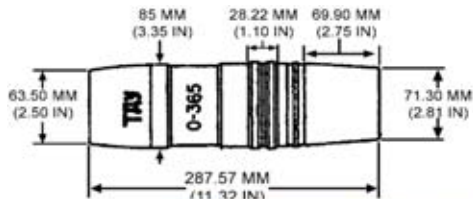

### U.S.S.R. PROJECTILE, 85-MM, HE, O-365 (ONE-PIECE)

Ordnance used with:  
 T-11, PROJECTILE, PTT  
 T-5, FUZE, PROJECTILE, PTT  
 VM-2, PROJECTILE, MT  
 UO-365, 85-MM, CARTRIDGE, HE  
 UO-365K, 85-MM, CARTRIDGE, FRAG

N.E.W. 650.00 G

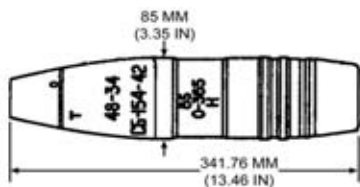

### U.S.S.R. PROJECTILE, 85-MM, HE, O-365 (TWO-PIECE)

Ordnance used with:  
 KTM-1, PROJECTILE, PD  
 KTM-1U, PROJECTILE, PD  
 KTM-1Y, PROJECTILE, PD  
 KTM-2, PROJECTILE, PD  
 KTM-3, PROJECTILE, PD  
 KTM3-1, PROJECTILE, PD  
 KTMZ-1, PROJECTILE, PD

N.E.W. 708.00 G

## U.S.S.R. PROJECTILE, 85-MM, HE, O-367A

Ordnance used with:  
KTM-1U, PROJECTILE, PD  
KTM-1Y, PROJECTILE, PD  
UO-367A, CARTRIDGE, 85MM, FRAG

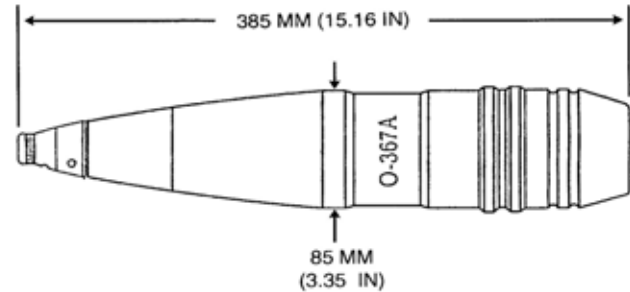

N.E.W. 670.00 G

## U.S.S.R. PROJECTILE, 85-MM, HEAT-FS, MODEL BK-2M

Ordnance used with:  
GPV-2, PROJECTILE, PIBD, SPITBACK  
UBK-1M, 85MM, CARTRIDGE, HEAT-FS

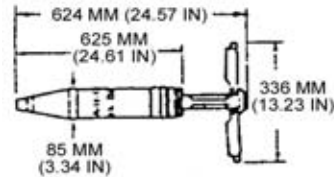

N.E.W. 962.00 G

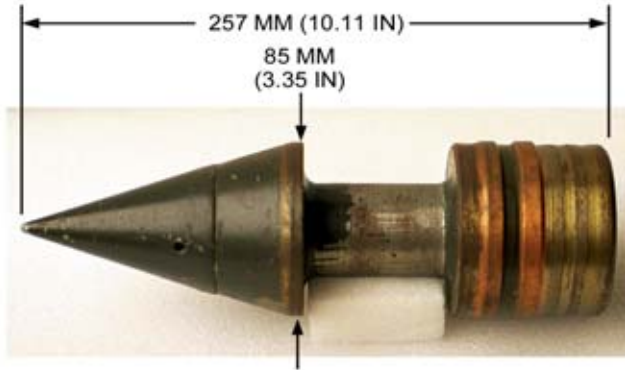

**U.S.S.R. PROJECTILE, 85-MM, HVAP-T, MODEL BR-365P**

Ordnance used with:  
UBR-365P, CARTRIDGE, 85MM, HVAP-T

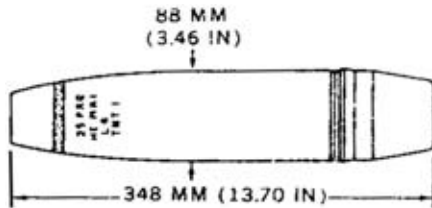

**U.K. PROJECTILE, 88-MM, HE, QF, (25-LB) MK 1**

Ordnance used with:  
L10, MARK 1, PROJECTILE, BD  
NO. 117 MK 10, PROJECTILE, PD  
NO. 117 MK 11, PROJECTILE, PD  
NO. 117 MK 12, PROJECTILE, PD  
NO. 117 MK 13, PROJECTILE, PD  
NO. 117 MK 14, PROJECTILE, PD  
NO. 117 MK 15, PROJECTILE, PD  
N.E.W. 800.00 G



## BELGIAN CARTRIDGE, 90-MM, HE, NR501

Ordnance used with:  
NR 2495, PROJECTILE, PD  
NR 501, 90-MM, HE-T



---

## BELGIAN CARTRIDGE, 90-MM, HEAT, MODELS NR 478 & NR 488

Ordnance used with:  
NR 488, 90-MM, HEAT  
NR 488, 90-MM, CARTRIDGE, HEAT  
NR 2 515, PROJECTILE, PIBD

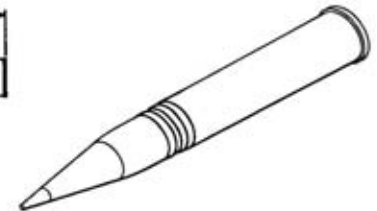
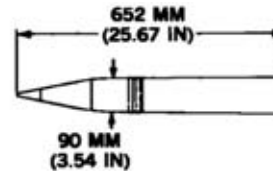

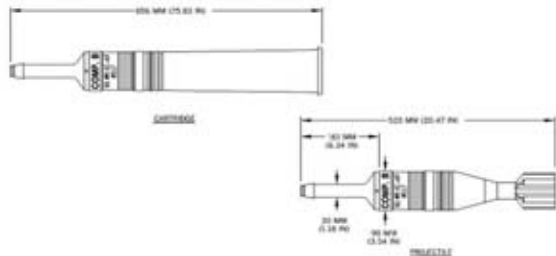

## BELGIAN CARTRIDGE, 90-MM, HEAT-T, M517

Ordnance used with:  
 M517, 90-MM, HEAT-T  
 M517, 90MM, CARTRIDGE, HEAT-T  
 M517, 90MM, HEAT-T  
 M509A1, PIBD  
 M509E6



N.E.W. 478.00 G

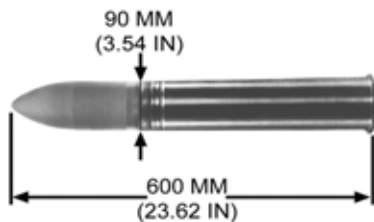

## BELGIAN CARTRIDGE, 90-MM, HEP-T, M625

Ordnance used with:  
 M625, 90-MM, HEP-T  
 M625, 90-MM, HESH-T  
 NR-503. 90-MM, HEP-T





**BELGIAN PROJECTILE, 90-MM, HE-FRAG, NR 219A1**

Ordnance used with:  
NR 2495, PROJECTILE, PD

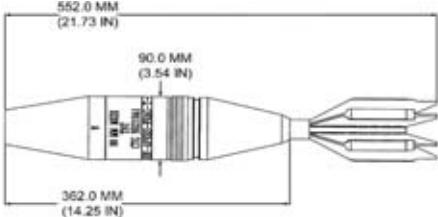

N.E.W. 1.31 KG

**BELGIAN PROJECTILE, 90-MM, HE-T, NR 501A2**

Ordnance used with:  
NR 2495, PROJECTILE, PD  
NR 501A2, 90-MM, CARTRIDGE, HE-T

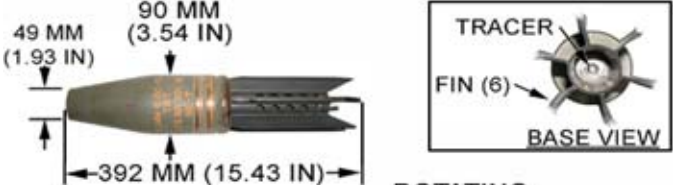

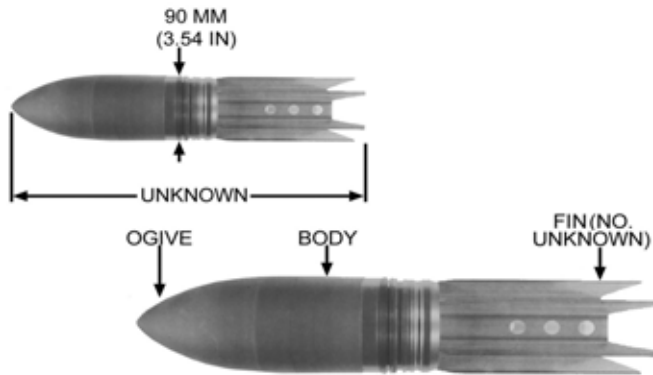

## BELGIAN PROJECTILE, 90-MM, HEP-T, M625

Ordnance used with:  
M625, 90-MM, CARTRIDGE, HEP-T  
M625, 90-MM, CARTRIDGE, HESH-T

N.E.W. 1.30 KG

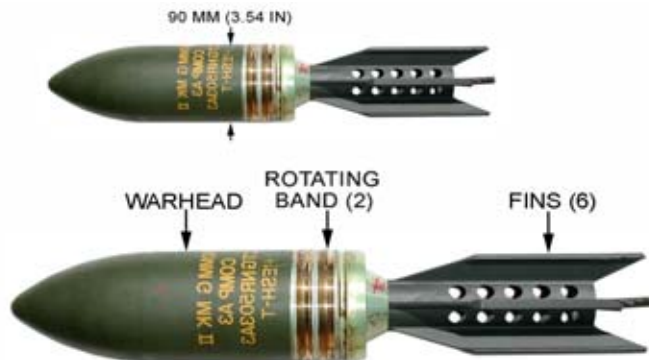

## BELGIAN PROJECTILE, 90-MM, HEP-T, NR 503 A3

Ordnance used with:  
NR 503 A3, 90MM, CARTRIDGE, HEP-T  
NR 503A3, 90MM, CARTRIDGE, HEP-T  
NR503A3, 90MM, CARTRIDGE, HEP-T  
NR 2 490, PROJECTILE, BD  
NR 2490, PROJECTILE, BD

N.E.W. 1.10 KG

## BELGIAN PROJECTILE, 90-MM, TP-T, NR6479A3

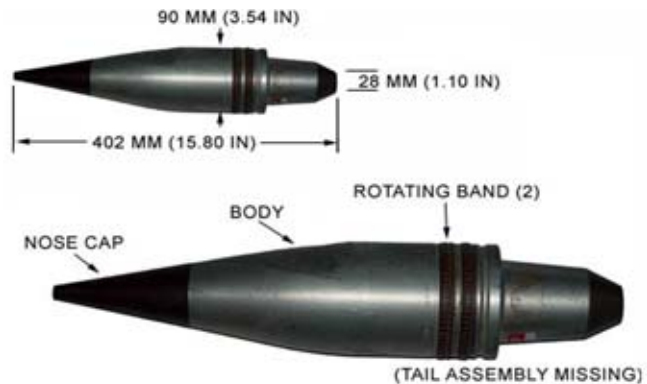

## FRENCH PROJECTILE, 90-MM, HE, MF-1

Ordnance used with:  
FUI-F2, PROJECTILE, PD  
FUI F1, PROJECTILE, PD

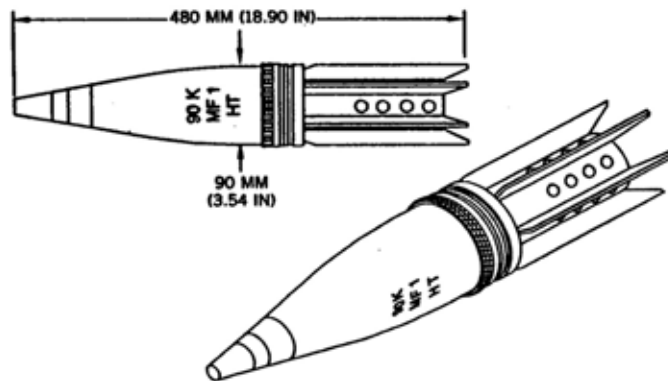

N.E.W. 945.00 G



## FRENCH PROJECTILE, 90-MM, HEAT-T, OCC 90 62

Ordnance used with:  
OCC 90 62, 90MM, CARTRIDGE, HEAT-T  
G4C, PROJECTILE, PIBD

N.E.W. 670.00 G

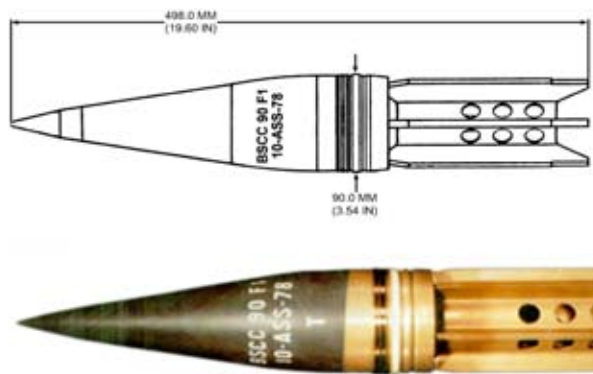

## FRENCH PROJECTILE, 90-MM, HEAT-TP, BSCC

## U.S. CARTRIDGE, 90-MM, HEAT, M371A1

Ordnance used with:  
M371A1, 90-MM, HEAT  
M530, PIBD  
T278E7, PIBD  
M509, PIBD  
M509A1, PIBD  
M509E6  
M509A2, PROJECTILE, PIBD  
N.E.W. 1.42 KG



## U.S. CARTRIDGE, 90-MM, HEAT, M371E1

Ordnance used with:  
M530, PIBD  
T278E7, PIBD  
M509, PIBD  
M509A1, PIBD  
M509E6  
M530A1, PIBD  
T278E8, PIBD  
N.E.W. 1.46 KG



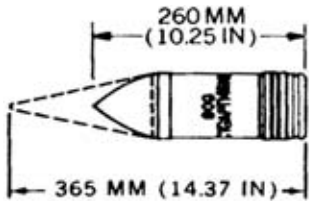

### U.S. PROJECTILE, 90-MM, AP-T, M318A1

Ordnance used with:  
M318, CARTRIDGE, 90 MM, AP-T  
T33E7, CARTRIDGE, 90 MM, AP-T



N.E.W. 1.00 G



### U.S. PROJECTILE, 90-MM, HE, M71

Ordnance used with:  
M48, PROJECTILE, PD  
M48A1, PROJECTILE, PD  
M48A2, FUZE, PROJECTILE, PD  
M48A3, FUZE, PROJECTILE, PD  
M501, FUZE, PROJECTILE, MTSQ  
M501A1, FUZE, PROJECTILE, MTSQ  
M502, FUZE, PROJECTILE, MTSQ

N.E.W. 2.25 LB

## U.S. PROJECTILE, 90-MM, HEAT, M371E1

Ordnance used with:  
M371E1, 90-MM, CARTRIDGE, HEAT

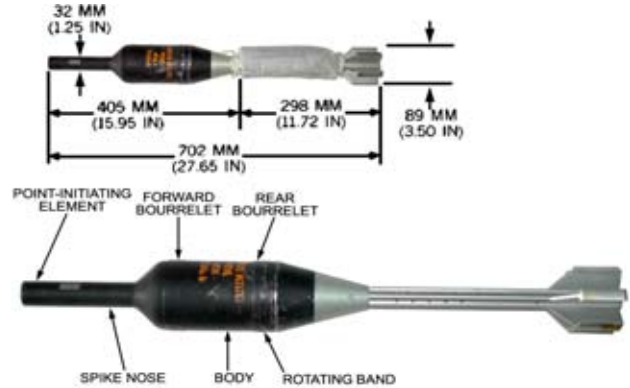

## FRENCH CARTRIDGE, 90-MM, HE, OE 90 F1

Ordnance used with:  
0E90F1, CARTRIDGE, 90-MM, HE  
FUI-F2, PROJECTILE, PD  
OE 90 F1, 90-MM, HE-T  
FUI F1, PROJECTILE, PD  
OE 90 F2, 90MM, CARTRIDGE, HE-T  
OE 90 F3, 90MM, CARTRIDGE, HE-T  
OE 90 F4, 90MM, CARTRIDGE, HE-T  
N.E.W. 1.55 KG

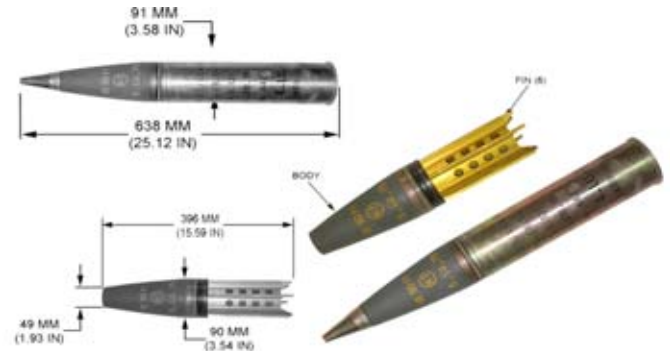



## CHINESE CARTRIDGE, 57-MM, HE-T, TYPE 59

Ordnance used with:  
 ML-2  
 ML-2, PROJOECTILE, PSDS  
 ML2, PROJECTILE, PD  
 LIU 2, PROJECTILE, PSDS  
 TYPE 59, 57MM, CARTRIDGE, HE  
 TYPE 59, 57MM, HE

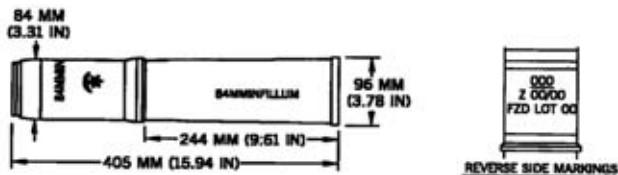

## SWEDISH CARTRIDGE, 84-MM, ILLUMINATION, FFV 545

Ordnance used with:  
 UNKNOWN, PTT  
 FFV 545, 84 MM, ILLUMINATING





## U.S.S.R. CARTRIDGE, 57-MM, APHE-T, UBR-281

Ordnance used with:  
MD-10, PROJECTILE, BD  
BR-281, 57-MM, APHE-T  
ZSU-57-2, AIR DEFENSE GUN, 57MM, TWIN  
S-60, AIR DEFENSE GUN, 57MM, TOWED

N.E.W. 18.00 G

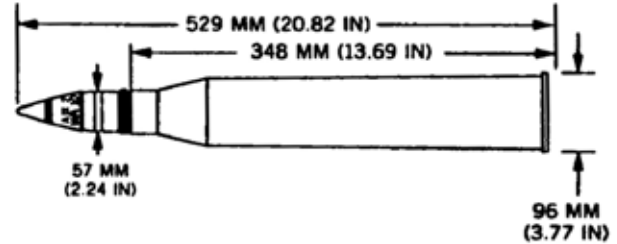

## U.S.S.R. CARTRIDGE, 57-MM, APHE-T, UBR-281U

Ordnance used with:  
MD-10, PROJECTILE, BD  
BR-281U, 57-MM, APHE-T  
ZSU-57-2, AIR DEFENSE GUN, 57MM, TWIN  
S-60, AIR DEFENSE GUN, 57MM, TOWED

N.E.W. 18.00 G

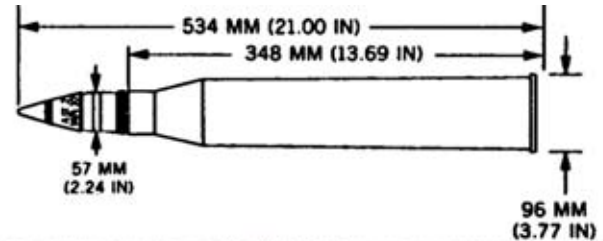

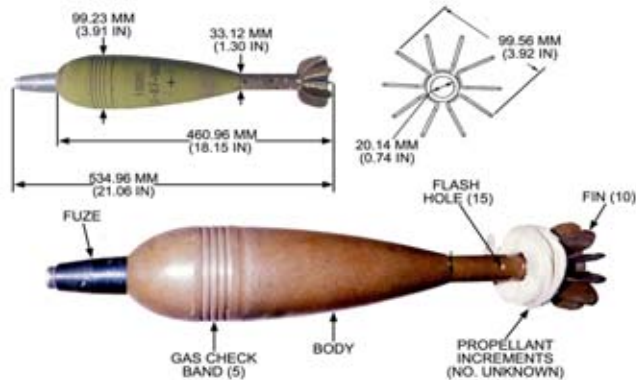

## CHINESE PROJECTILE, 100-MM, HE, MORTAR, TYPE 71

Ordnance used with:  
 PAI-4, PROJECTILE, PD  
 TYPE PAI-4, PROJECTILE, PD  
 MP-4, PROJECTILE, PD  
 MP4, PROJECTILE, PD  
 TYPE 71, 100MM, HE, MORTAR  
 M-12  
 M12, PROJECTILE, PD  
 N.E.W. 938.00 G

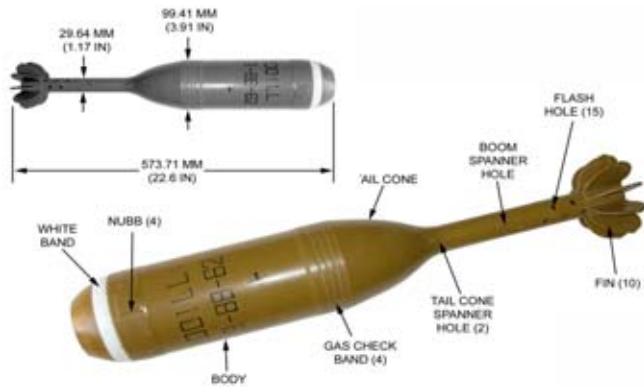

## CHINESE PROJECTILE, 100-MM, ILLUM, MORTAR, TYPE 71

Ordnance used with:  
 MS-3A, PROJECTILE, PTT  
 SHI-3, PROJECTILE, PTT  
 TYPE 71, 100MM, CARTRIDGE, ILLUMINATION, MORTAR

N.E.W. 870.75 G

## U.S.S.R. PROJECTILE, 100-MM, HE, OF15

Ordnance used with:  
V-429E, PROJECTILE, PD  
UOF-3, 100-MM, CARTRIDGE, HE  
UOF3, 100-MM, CARTRIDGE, HE

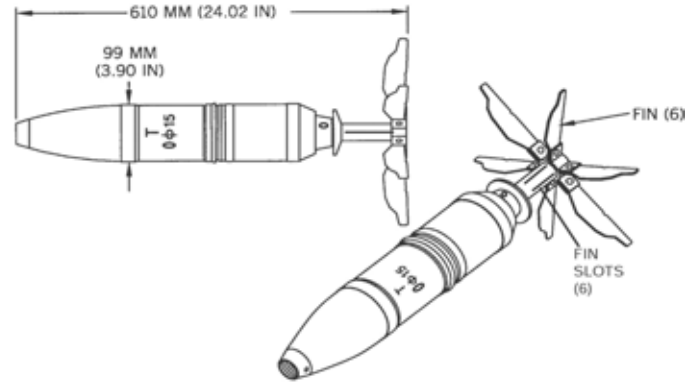

N.E.W. 2.23 KG

## BULGARIAN PROJECTILE, 100-MM, FRAG-HE, OF-412

Ordnance used with:  
VUBS-1, PROJECTILE, PDSD  
NSC-1, PROJECTILE, PDSD  
RGM, PROJECTILE, PD  
RGM-2, PROJECTILE, PD  
RGM-3, PROJECTILE, PD  
RGM-6, PROJECTILE, PD  
V-429, PROJECTILE, PD

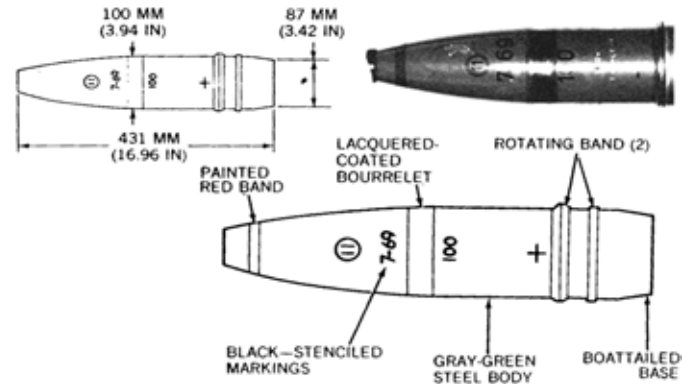

**CHINESE PROJECTILE, 100-MM, APHE, PSV**

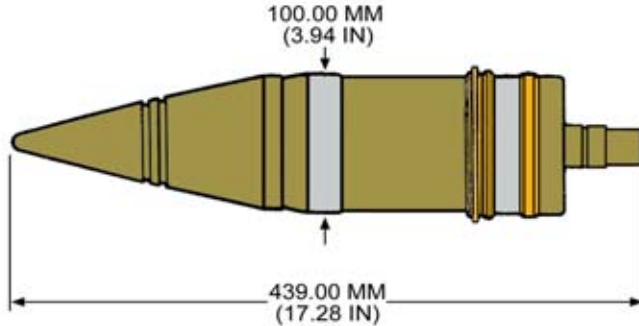

N.E.W. 0.13 LB

**CHINESE PROJECTILE, 100-MM, FRAG, HE, MODEL UNKNOWN**

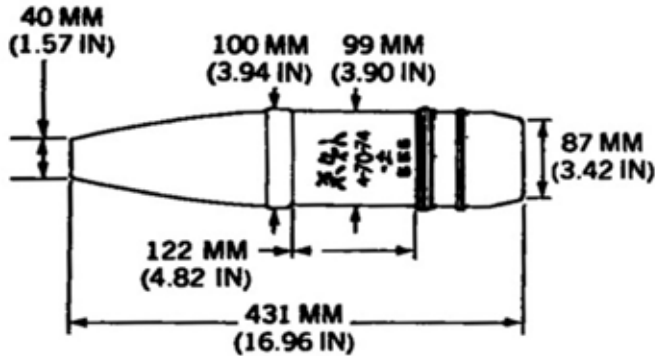

Ordnance used with:  
ML-5  
ML5, PROJECTILE, PD  
UNKNOWN, 100MM, CARTRIDGE, HE-FRAG

N.E.W. 1.50 KG

## CHINESE PROJECTILE, 100-MM, HE, MORTAR, MODEL UNKNOWN

Ordnance used with:  
PUI-4, PROJECTILE, PD

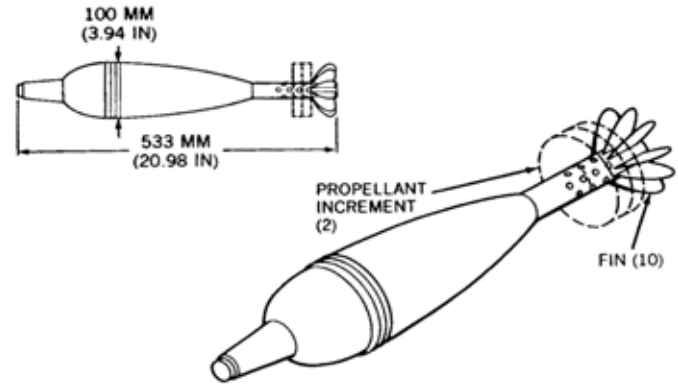

N.E.W. 960.00 G

## CHINESE PROJECTILE, 100-MM, HEAT, TYPE 73

Ordnance used with:  
MD-1G, PROJECTILE, PIBD  
TYPE 73, CARTRIDGE (FIXED), 100-MM, HEAT-T

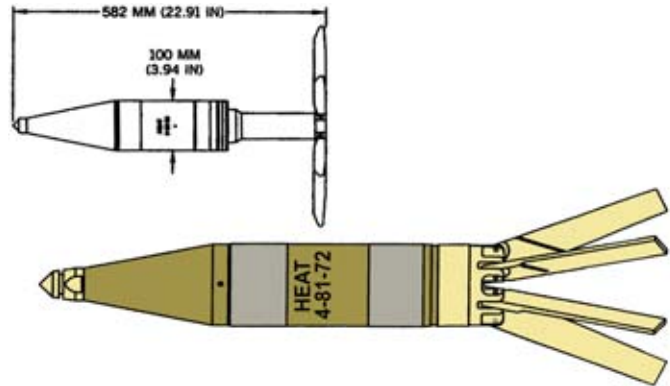

N.E.W. 897.00 G

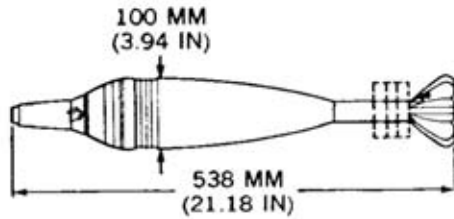

### CHINESE PROJECTILE, 100-MM, SMOKE, MORTAR, MODEL UNKNOWN

Ordnance used with:  
PUI-4, PROJECTILE, PD

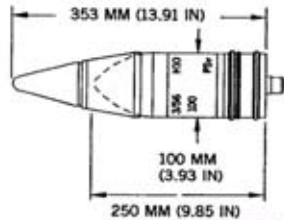

### CZECHOSLOVAKIAN PROJECTILE, 100-MM, APHE-T

Ordnance used with:  
JPSV CARTRIDGE, 100-MM, APHE-T  
DBR-2, PROJECTILE, BD  
DZ 30, PROJECTILE, BD  
PD 30, PROJECTILE, BD



N.E.W. 96.00 G

## CZECHOSLOVOKIAN PROJECTILE, 100-MM, HEAT, PRSV

Ordnance used with:  
JPRSV, CARTRIDGE, 100-MM, HEAT  
NZ-42, PROJECTILE, PIBD

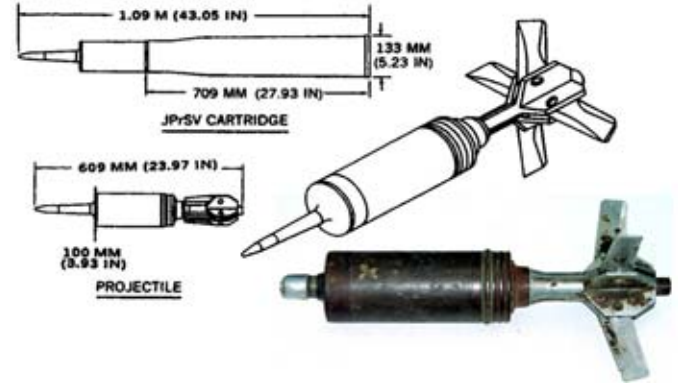

N.E.W. 936.00 G

## IRAQI PROJECTILE, 100-MM, APHE-T, MODEL UNKNOWN

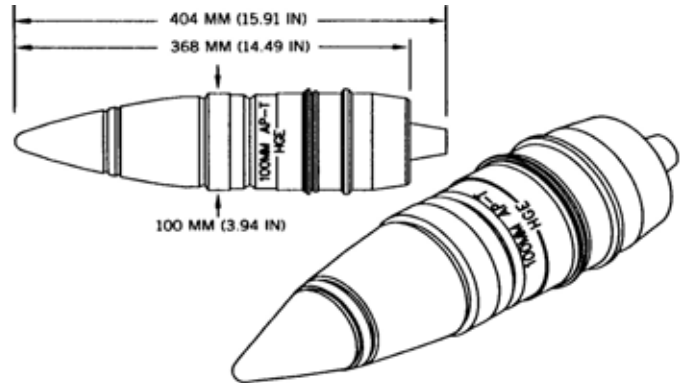

N.E.W. 60.00 G

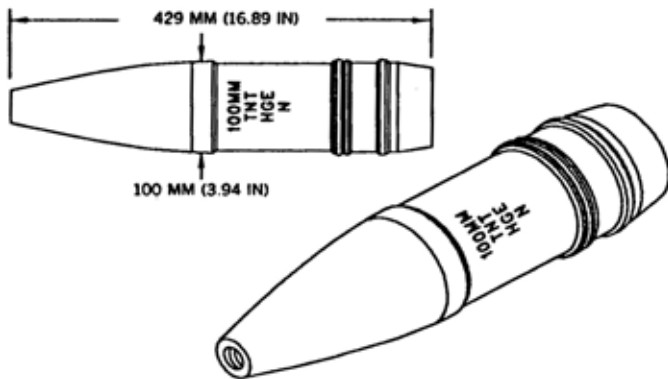

### IRAQI PROJECTILE, 100-MM, HE, MODEL UNKNOWN

Ordnance used with:  
V-429, PROJECTILE, PD  
V-429E, PROJECTILE, PD

N.E.W. 1.50 KG

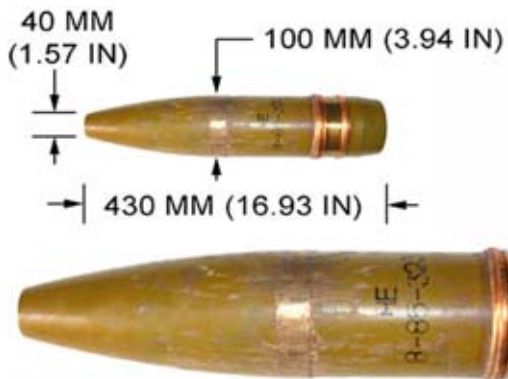

### IRAQI PROJECTILE, 100-MM, HE-FRAG, UO-415

Ordnance used with:  
ML-5  
ML5, PROJECTILE, PD  
UO-415, CARTRIDGE, 100MM, FRAG

N.E.W. 1.50 KG



**PAKISTANI PROJECTILE, 100-MM, HEAT-T, MODEL UNKNOWN**

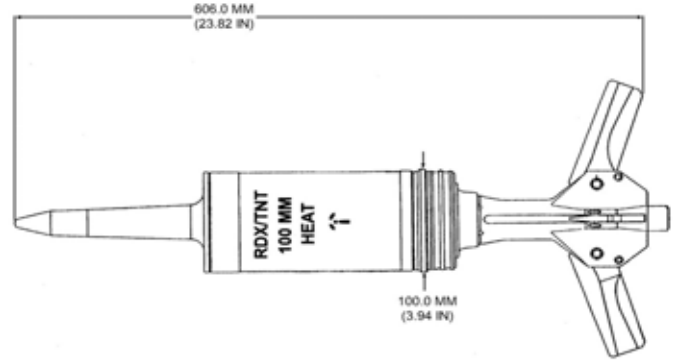

N.E.W. 0.95 KG

**ROMANIAN PROJECTILE, 100-MM, HEAT-T, BK412R**

Ordnance used with:  
GPV-2R, PROJECTILE, PIBD  
UBK-412R, 100-MM, HEAT-T, CARTRIDGE





## ROMANIAN PROJECTILE, 100-MM, HEAT-T, HXG

Ordnance used with:  
GPV-2, PROJECTILE, PIBD, SPITBACK  
HXG, 100 MM, HEAT-T, CARTRIDGE  
HXG, CTG, 100MM, HEAT-T  
GPV-2R, PROJECTILE, PIBD

N.E.W. 1.04 KG

## U.S.S.R. CARTRIDGE, 100-MM, 3UBM10 WITH PROJECTILE, APDS-FS, 3BM24

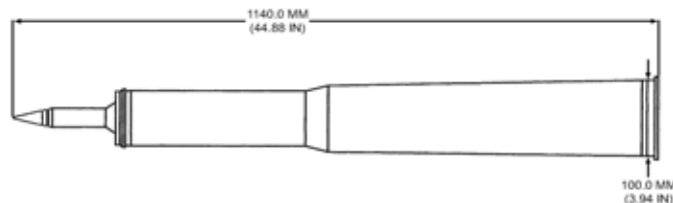

Ordnance used with:  
3BM24, 100-MM, APFSDS  
BM-24, 100-MM, APFSDS  
3UBM10, CARTRIDGE, 100-MM, APFSDS  
UBM-10, CARTRIDGE, 100-MM, APFSDS

## U.S.S.R. CARTRIDGE, 100-MM, HE, UOF-3

Ordnance used with:  
V-429E, PROJECTILE, PD  
OF15, 100-MM, HE

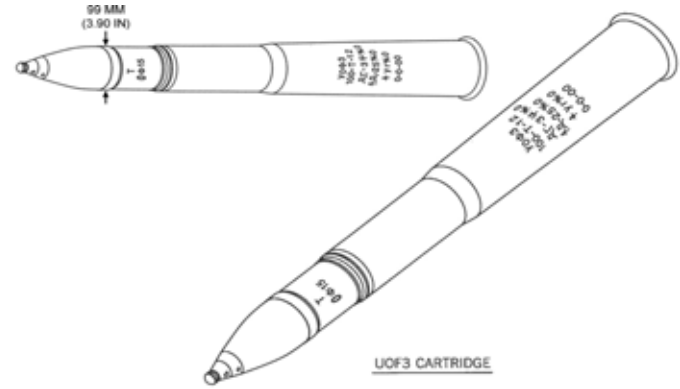

## U.S.S.R. CARTRIDGE, 100-MM, HVAPDS-T, MODEL UBM-6

Ordnance used with:  
BM-8, 100-MM, HVAPDS-T  
BM8, 100-MM, HVAPDS-T

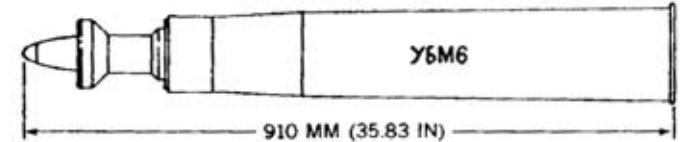

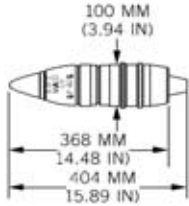

## U.S.S.R. PROJECTILE, 100-MM, APHE OR APHE-T, BR-412B

Ordnance used with:  
 DBR, PROJECTILE, BD  
 DBR-2, PROJECTILE, BD  
 UBR-412B, CARTRIDGE, 100MM, APHE-T  
 UBZR, CARTRIDGE, 100-MM, APHE-T  
 MD-8, PROJECTILE, BD  
 UBR-412, CARTRIDGE, 100-MM, APHE OR APHE-T

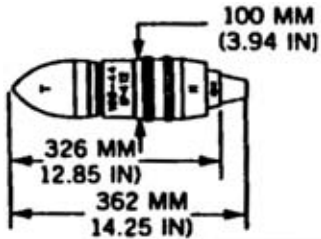

## U.S.S.R. PROJECTILE, 100-MM, APHE-T, BR-412

Ordnance used with:  
 DBR, PROJECTILE, BD  
 DBR-2, PROJECTILE, BD  
 UBR-412, 100-MM, CARTRIDGE, APHE-T  
 MD-8, PROJECTILE, BD

N.E.W. 54.00 G

## U.S.S.R. PROJECTILE, 100-MM, FRAG, HE, MODEL F-412

Ordnance used with:  
RGM, PROJECTILE, PD

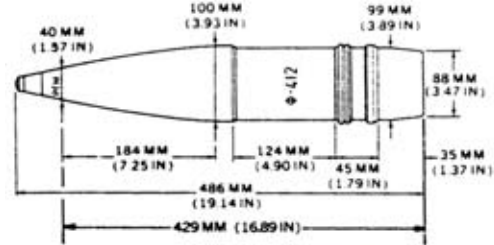

## U.S.S.R. PROJECTILE, 100-MM, FRAG, HE, MODEL OF-412

Ordnance used with:  
NSC-1, PROJECTILE, PDSD  
RGM, PROJECTILE, PD  
RGM-2, PROJECTILE, PD  
RGM-3, PROJECTILE, PD  
RGM-6, PROJECTILE, PD  
V-429, PROJECTILE, PD  
V-429E, PROJECTILE, PD

N.E.W. 1.46 KG

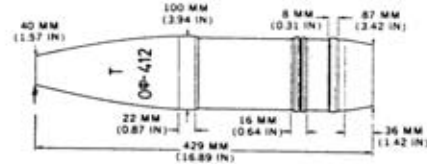

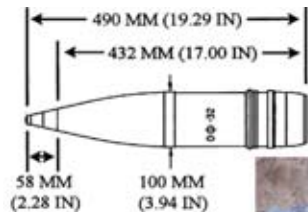

## U.S.S.R. PROJECTILE, 100-MM, HE, OF-32

Ordnance used with:  
 V-429, PROJECTILE, PD  
 V-429E, PROJECTILE, PD  
 3UOF10, 100-MM, CARTRIDGE, HE  
 UOF-10, 100-MM, CARTRIDGE, HE  
 3UOF11, CARTRIDGE, 100MM, HE

N.E.W. 1.70 KG

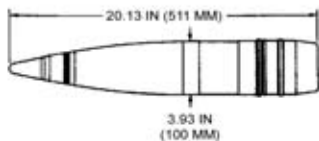

## U.S.S.R. PROJECTILE, 100-MM, HE-FRAG, MODEL 0-415

Ordnance used with:  
 KTM-1, PROJECTILE, PD  
 VM-30, PROJECTILE, MT  
 VM-30L, PROJECTILE, MT  
 UO-415, CARTRIDGE, 100MM, FRAG

## U.S.S.R. PROJECTILE, 100-MM, HEAT, 3BK16M

Ordnance used with:  
3UBK8, 100-MM, CARTRIDGE, HEAT-FS  
V-15, FUZE, PROJECTILE, PIBD  
UBK-8M, CARTRIDGE, 100MM, HEAT

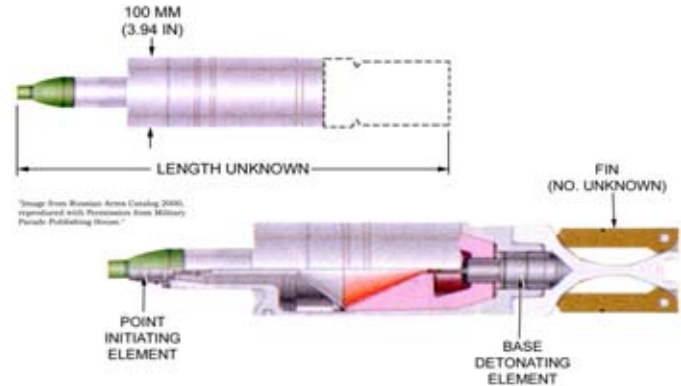

## U.S.S.R. PROJECTILE, 100-MM, HEAT-FS, 3BK-5M

Ordnance used with:  
GPV-2, PROJECTILE, PIBD, SPITBACK  
UBK-4M, CARTRIDGE, 100-MM, HEAT-FS

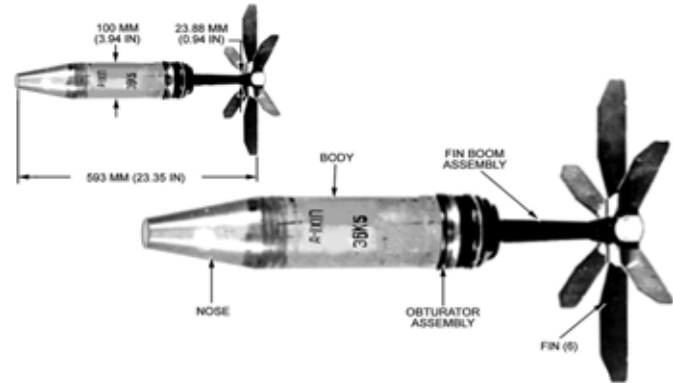

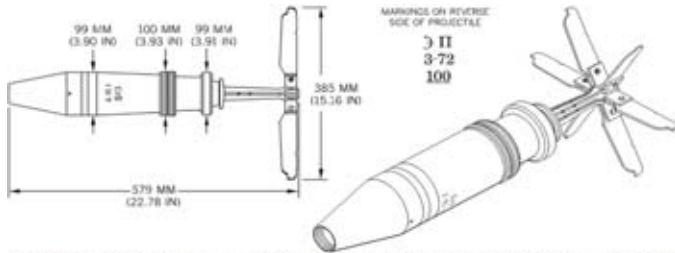

### U.S.S.R. PROJECTILE, 100-MM, HEAT-FS-T, BK-3

Ordnance used with:  
 GPV-2, PROJECTILE, PIBD, SPITBACK  
 GPV-3, PROJECTILE, PIBD  
 UBK-2, 100MM, CARTRIDGE, HEAT

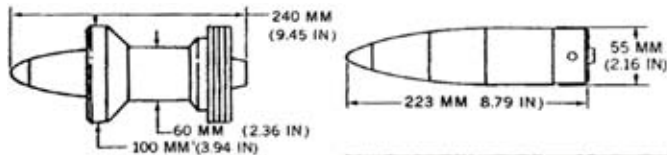

### U.S.S.R. PROJECTILE, 100-MM, HVAPDS-T, MODEL BM8

Ordnance used with:  
 UBM-6, 100-MM, CARTRIDGE, HVAPDS-T





## YUGOSLAV PROJECTILE, 100-MM, HE, M63P1

Ordnance used with:  
UTIU M63P1, PROJECTILE, PD  
UTIU M63, PROJECTILE, PD

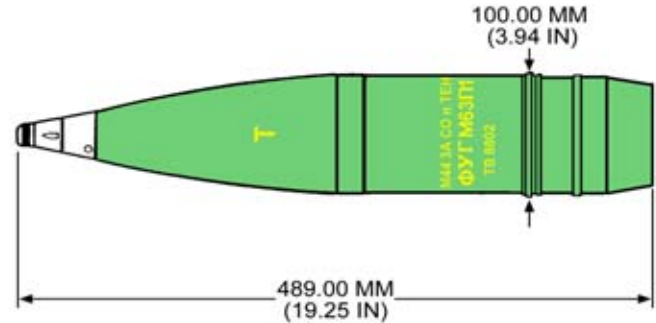

N.E.W. 1.46 KG

## YUGOSLAV PROJECTILE, 100-MM, HEAT-T, MODEL M69

Ordnance used with:  
AU-16, PROJECTILE, PIBD  
M69, PROJECTILE, PIBD  
UT PE M69, PROJECTILE, PIBD  
UT-PE.M69, PROJECTILE, PIBD  
M69, 100-MM, HEAT-T, CARTRIDGE



### BELGIAN CARTRIDGE, 90-MM, SMOKE-T, NR502A3

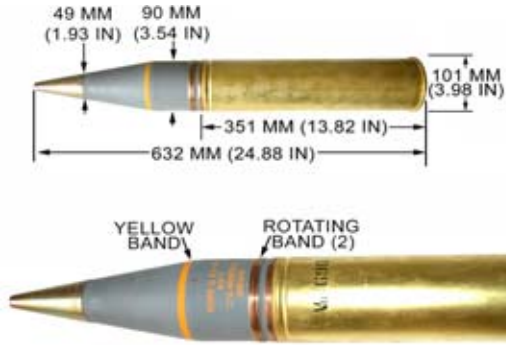

### BELGIAN CARTRIDGE, 90-MM, HE-T, NR 501A2



Ordnance used with:  
NR 2495, PROJECTILE, PD  
NR 501A2, 90MM, HE-T

## BELGIAN CARTRIDGE, 90-MM, HEP-T, NR 503 A3

Ordnance used with:  
NR 2 490, PROJECTILE, BD  
NR 2490, PROJECTILE, BD  
NR 503 A3, 90MM, HEP-T  
NR503 A3, 90MM, HEP-T  
NR503A3, 90MM, HEP-T

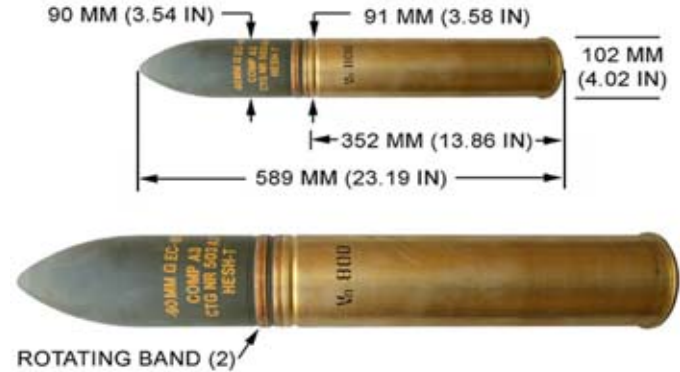

## FRENCH CARTRIDGE, 90-MM, HEAT-T, OCC 90 62

Ordnance used with:  
OCC 90 62, 90MM, HEAT-T  
G4C, PROJECTILE, PIBD

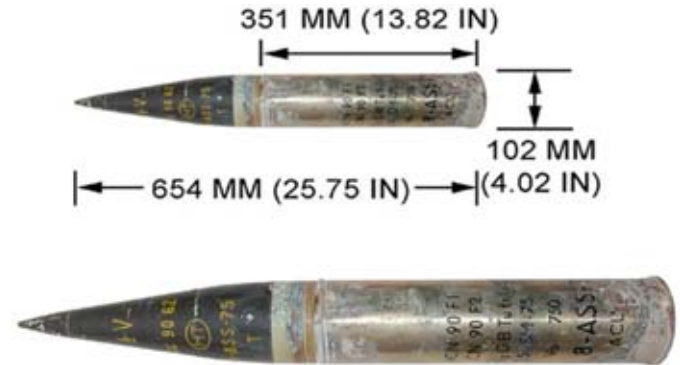

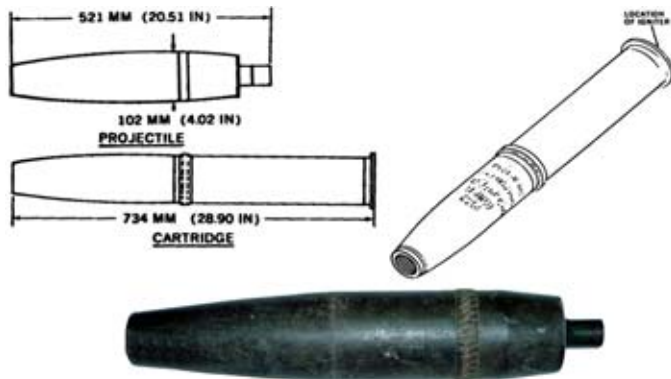

## U.S. PROJECTILE, 105-MM, HERA, M548 (XM548E1)

Ordnance used with:

M513 (T226), FUZE, PROJECTILE, VT  
M513A1 (T226E2), FUZE, PROJECTILE, VT  
M513A2, FUZE, PROJECTILE, VT  
T226E3, FUZE, PROJECTILE, VT  
M513A2/1, FUZE, PROJECTILE, VT  
T226E3A, FUZE, PROJECTILE, VT  
M513A2/2, FUZE, PROJECTILE, VT

N.E.W. 3.82 KG

---

## U.S.S.R. CARTRIDGE, 85-MM, APHE-T, UBR-365K



Ordnance used with:

BR-365K, 85 MM, APHE-T  
MD-10, PROJECTILE, BD  
MD-5, PROJECTILE, BD  
MD-7, FUZE, PROJECTILE, BD  
MD-8, PROJECTILE, BD  
KS-12, AIR DEFENSE GUN, 85MM, TOWED

**IRANIAN PROJECTILE, 105-MM, HE, MODEL UNKNOWN**



**IRAQI PROJECTILE, 105-MM, HE, MODEL UNKNOWN**

Ordnance used with:  
V-429, PROJECTILE, PD  
V-429E, PROJECTILE, PD  
B-90, PROJECTILE, MTSQ  
V-90, PROJECTILE, MTSQ

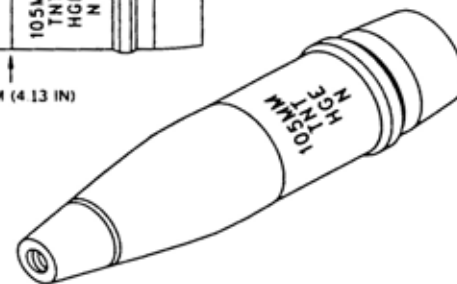
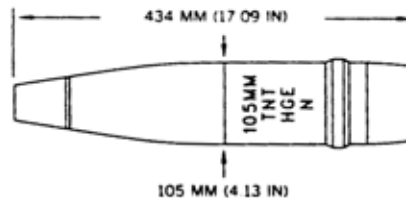

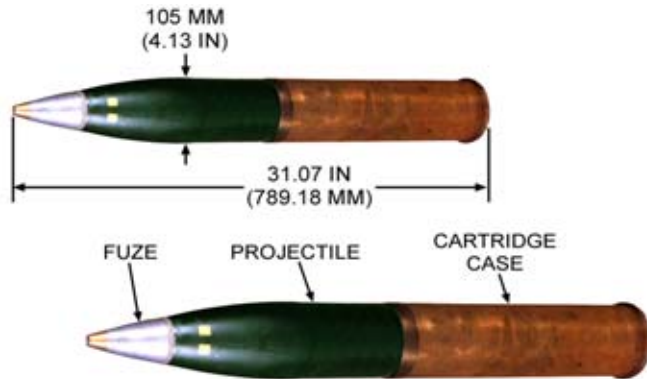

## U.S. CARTRIDGE, 105-MM, HE, M1

Ordnance used with:

M1, 105-MM, HE  
 M48, PROJECTILE, PD  
 M48A1, PROJECTILE, PD  
 M48A2, FUZE, PROJECTILE, PD  
 M48A3, FUZE, PROJECTILE, PD  
 M500, FUZE, PROJECTILE, MTSQ  
 M501, FUZE, PROJECTILE, MTSQ

N.E.W. 3.59 KG

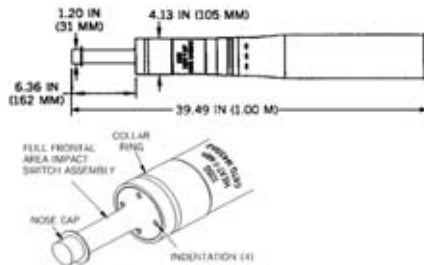

## U.S. CARTRIDGE, 105-MM, HEAT-T-MP, M456A2

Ordnance used with:

M456A2, 105-MM, HEAT-T-MP  
 M509, PIBD  
 M509A1, PIBD  
 M509E6  
 M509A2, PROJECTILE, PIBD

N.E.W. 13.25 LB



## U.S. CARTRIDGE, 105-MM, SMOKE, WP, M60A1

Ordnance used with:  
M508, PROJECTILE, PD  
M508A1, PROJECTILE, PD  
M51A5, FUZE, PROJECTILE, PD  
M557, FUZE, PROJECTILE, PD  
M55A2, FUZE, PROJECTILE, TSQ  
M55A3, FUZE, PROJECTILE, TSQ  
M55A1, PROJECTILE, TSQ

N.E.W. 3.00 LB

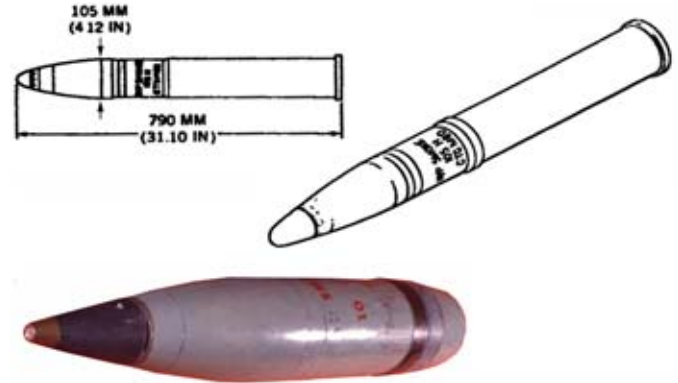

## U.S. CARTRIDGE, 106-MM, HEAT, M344

Ordnance used with:  
M530, PIBD  
T278E7, PIBD  
M509, PIBD  
M509A1, PIBD  
M509E6  
M344, PROJECTILE, 106-MM, HEAT  
M509A2, PROJECTILE, PIBD

N.E.W. 5.03 KG

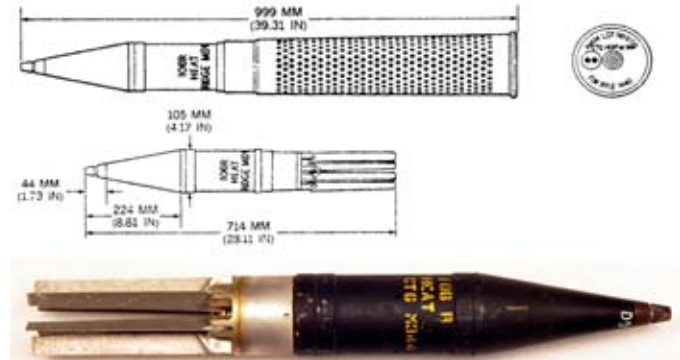



### U.S. PROJECTILE, 105-MM, HE, M1

Ordnance used with:  
M48, PROJECTILE, PD  
M48A1, PROJECTILE, PD  
M48A2, FUZE, PROJECTILE, PD  
M48A3, FUZE, PROJECTILE, PD  
M500, FUZE, PROJECTILE, MTSQ  
M501, FUZE, PROJECTILE, MTSQ  
M501A1, FUZE, PROJECTILE, MTSQ

N.E.W. 2.30 KG



### U.S. PROJECTILE, 105-MM, HEAT, M67

Ordnance used with:  
M62, PROJECTILE, BD  
M62A2, PROJECTILE, BD  
M62A1, PROJECTILE, BD  
M91A2, PROJECTILE, BD  
M67, PROJECTILE, BD  
M14, 105MM, PROPELLING CHARGE

N.E.W. 2.10 KG



## U.S. PROJECTILE, 105-MM, HEAT-T-MP, M456A2

Ordnance used with:

M509, PIBD

M509A1, PIBD

M509E6

M509A2, PROJECTILE, PIBD

M456A2, 105-MM, CARTRIDGE, HEAT-T-MP

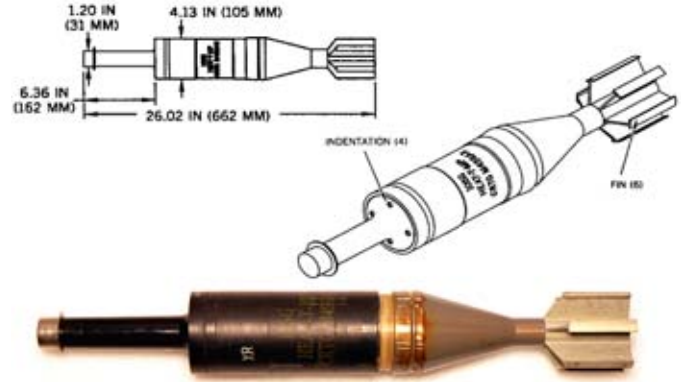

N.E.W. 2.00 LB

## U.S. PROJECTILE, 105-MM, HERA, M548

Ordnance used with:

M501, FUZE, PROJECTILE, MTSQ

M501A1, FUZE, PROJECTILE, MTSQ

M513 (T226), FUZE, PROJECTILE, VT

M513A1 (T226E2), FUZE, PROJECTILE, VT

M513A2, FUZE, PROJECTILE, VT

T226E3, FUZE, PROJECTILE, VT

M513A2/1, FUZE, PROJECTILE, VT

N.E.W. 3.23 KG

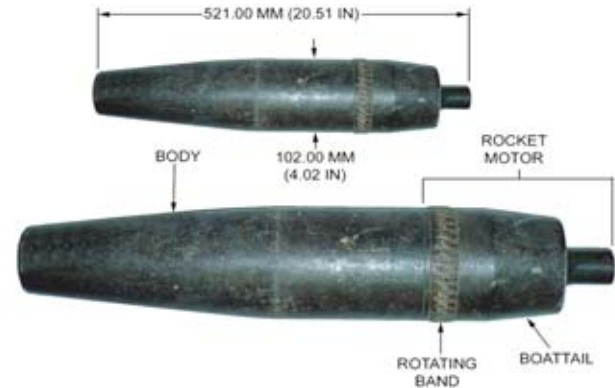

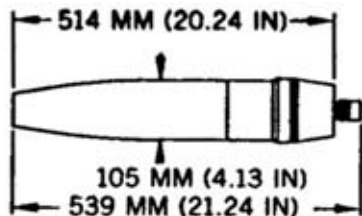

## U.S. PROJECTILE, 105-MM, HERA, M912

Ordnance used with:  
 M582, FUZE, PROJECTILE, MTSQ  
 M582A1, FUZE, PROJECTILE, MTSQ  
 M728, FUZE, PROJECTILE, PROXIMITY  
 M732 PROJECTILE, PROXIMITY  
 M739, FUZE, PROJECTILE, PD  
 M739A1, FUZE, PROJECTILE, PD  
 M913, CARTRIDGE, 105-MM, HERA

N.E.W. 5.46 KG

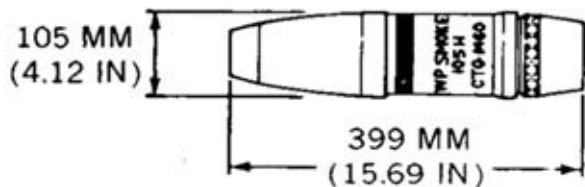

## U.S. PROJECTILE, 105-MM, SMOKE, WP, M60-SERIES

Ordnance used with:  
 M501, FUZE, PROJECTILE, MTSQ  
 M501A1, FUZE, PROJECTILE, MTSQ  
 M508, PROJECTILE, PD  
 M508A1, PROJECTILE, PD  
 M51A5, FUZE, PROJECTILE, PD  
 M55, PROJECTILE, TSQ  
 M557, FUZE, PROJECTILE, PD

N.E.W. 95.20 G

## YUGOSLAV PROJECTILE, 105-MM, HE, M1

Ordnance used with:  
BU-105 M79, PROJECTILE, PROXIMITY/PD  
AU-10, PROJECTILE, PF  
UTU M557, PROJECTILE, PD

N.E.W. 2.20 KG

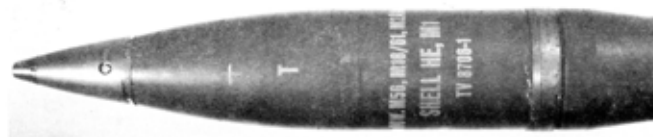
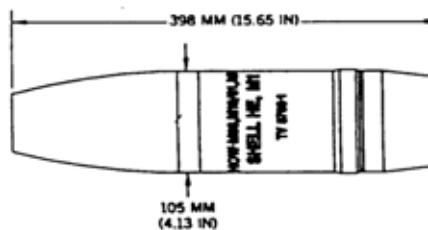

## YUGOSLAV PROJECTILE, 105-MM, HEP-T, M67

Ordnance used with:  
AU-14P1, FUZE, PROJECTILE, BD  
DI M61, BD, PROJECTILE FUZE  
M61, FUZE, PROJECTILE, BD

N.E.W. 2.06 KG

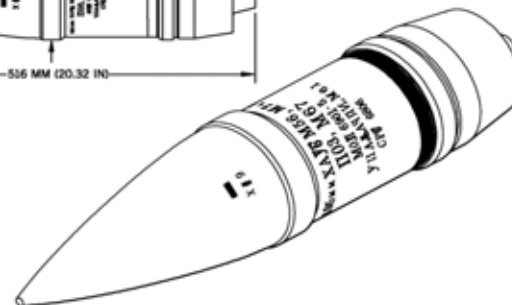
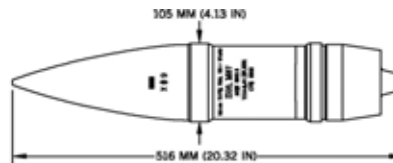

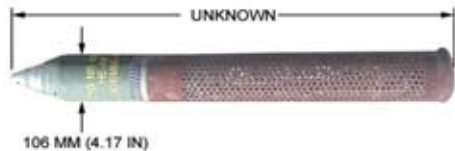

**BELGIAN PROJECTILE, 106-MM, RECOILLESS RIFLE,  
HE-AP, NR 483 A1**

Ordnance used with:  
NR 2421, PROJECTILE, PD  
NR 483A1, 106MM, HE-AP

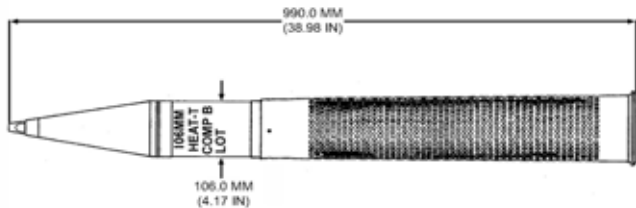

**IRANIAN CARTRIDGE, 106-MM, HEAT, RECOILLESS  
RIFLE, MODEL UNKNOWN**

Ordnance used with:  
RAAD, 106MM, ANTITANK GUN, RECOILLESS RIFLE  
M509A1, PIBD  
M509E6

N.E.W. 1.20 KG

## U.S.S.R. PROJECTILE, 100-MM, APC-T, MODEL BR-412D

Ordnance used with:  
DBR-2, PROJECTILE, BD  
MD-8, PROJECTILE, BD

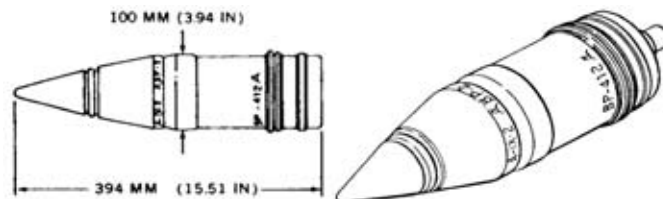

N.E.W. 2.00 OZ

## U.S.S.R. PROJECTILE, 107-MM, BK-883

Ordnance used with:  
BK-883, 107-MM, HEAT-T  
GK-2, FUZE, PROJECTILE, PD

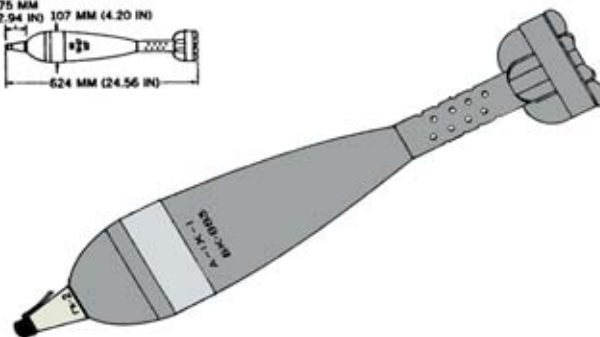
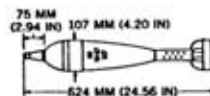

**U.S.S.R. PROJECTILE, 107-MM, MORTAR, HE-FRAG,  
OF-883A**

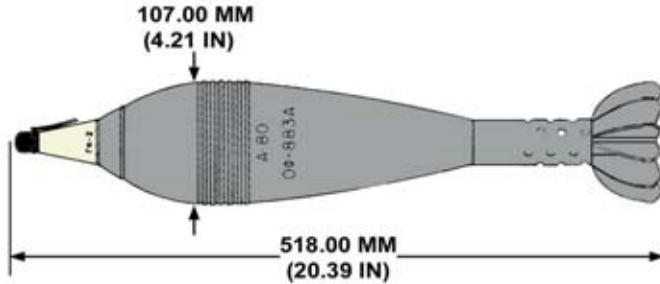

Ordnance used with:  
D-1, PROJECTILE, TSQ  
GK-2, FUZE, PROJECTILE, PD

N.E.W. 2.10 KG

**CHINESE CARTRIDGE, 85-MM, HE, MODEL  
UNKNOWN**



Ordnance used with:  
ML-5  
ML5, PROJECTILE, PD  
MODEL UNKNOWN, 85-MM, HE



## U.S.S.R. CARTRIDGE, 85-MM, APHE-T, UBR-365

Ordnance used with:  
BR-365, 85-MM, APHE-T  
MD-10, PROJECTILE, BD  
MD-8, PROJECTILE, BD  
KS-12, AIR DEFENSE GUN, 85MM, TOWED

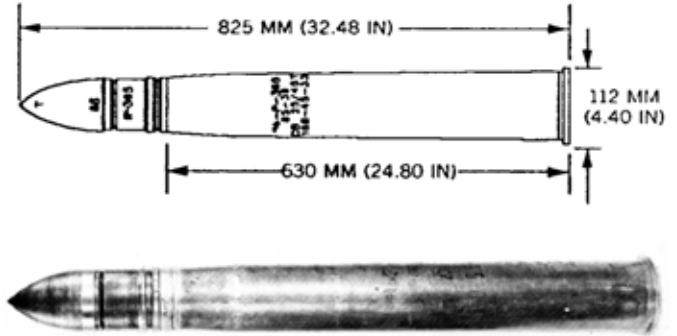

## U.S.S.R. CARTRIDGE, 85-MM, FIXED, FRAG, MODEL UO-365K

Ordnance used with:  
O-365, 85-MM, PROJECTILE, HE, (2 PIECE)  
O-365K, 85-MM, FRAG  
KTM-1, PROJECTILE, PD  
KTM-1U, PROJECTILE, PD  
KTM-1Y, PROJECTILE, PD  
KTM3-1, PROJECTILE, PD  
KTMZ-1, PROJECTILE, PD  
N.E.W. 3.39 KG





### **U.S.S.R. CARTRIDGE, 85-MM, HE, UO-365**



Ordnance used with:  
O-365, 85-MM, PROJECTILE, HE, (2 PIECE)  
KTM3-1, PROJECTILE, PD  
KTMZ-1, PROJECTILE, PD  
T-11, PROJECTILE, PTT  
T-5, FUZE, PROJECTILE, PTT  
VM-2, PROJECTILE, MT  
O-365 (ONE-PIECE), 85-MM, HE-FRAG



### **EGYPTIAN CARTRIDGE, 115-MM, HE, MODEL UNKNOWN**

Ordnance used with:  
AU-20E, PROJECTILE, PD

N.E.W. 7.29 KG



## U.S.S.R. CARTRIDGE, 115-MM, APFSDS-T, UBM-9

Ordnance used with:  
3BM21, 115-MM, APFSDS  
BM-21, 115-MM, APFSDS

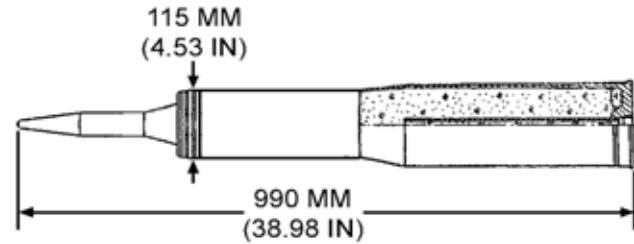

---

## U.S.S.R. PROJECTILE, 115-MM, APFSDS-T, BM-21

Ordnance used with:  
3UBM9, CARTRIDGE, 115-MM, APFSDS  
UBM-9, CARTRIDGE, 115-MM, APFSDS

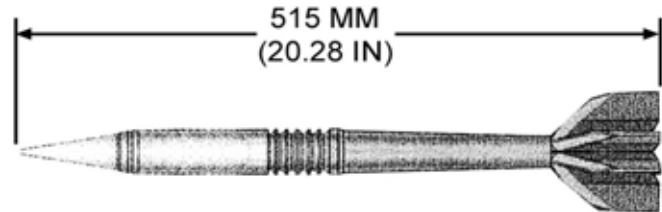

**U.S.S.R. PROJECTILE, 115-MM, APFSDS-T, BM-3**

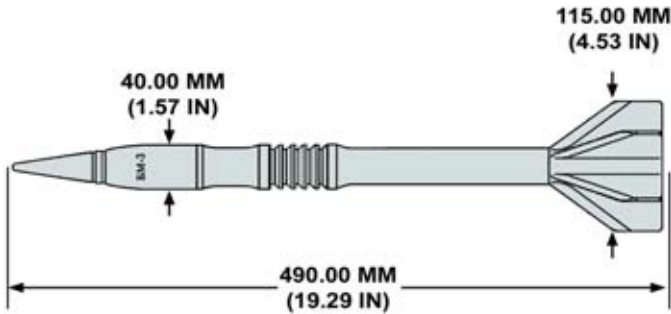

Ordnance used with:  
UBM-3, 115-MM, CARTRIDGE, HVAPDSFS-T  
BM-3, PROJECTILE, 115 MM, APFSDS-T

**U.S.S.R. PROJECTILE, 115-MM, FRAG-HE, OF-27**



Ordnance used with:  
V-429E, PROJECTILE, PD  
3UOF37, 115-MM, CARTRIDGE, FRAG-HE  
UOF-37, 115-MM, CARTRIDGE, FRAG-HE

## U.S.S.R. PROJECTILE, 115-MM, FS, HEAT, MODEL BK-4M

Ordnance used with:  
GPV-2, PROJECTILE, PIBD, SPITBACK  
UBK-3, 115 MM, HEAT-T, CARTRIDGE  
UBK-3M, 115-MM, CARTRIDGE, FS, HEAT

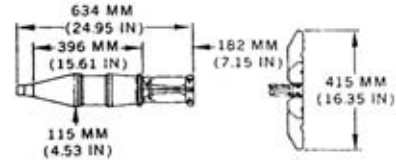

N.E.W. 1.51 KG

## U.S.S.R. PROJECTILE, 115-MM, HE, FRAG, MODEL OF-18

Ordnance used with:  
V-429, PROJECTILE, PD  
V-429E, PROJECTILE, PD  
D-1-U, PROJECTILE, TSQ  
D-1U, PROJECTILE, TSQ  
UOF-6, 115-MM, CARTRIDGE, HE, FRAG

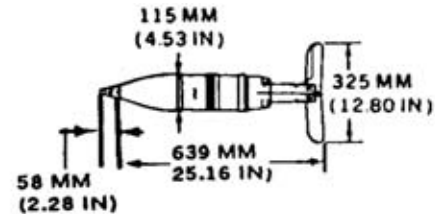

N.E.W. 2.70 KG

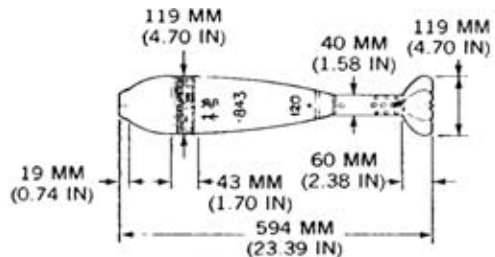

### CHINESE PROJECTILE, 120-MM, HE, MORTAR, TYPE 843

Ordnance used with:  
 MJ-12, PROJECTILE, PD  
 M-12  
 M12, PROJECTILE, PD  
 TYPE 12, PROJECTILE, PD

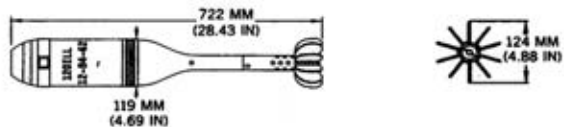

### CHINESE PROJECTILE, 120-MM, ILLUM, MORTAR, TYPE 55

Ordnance used with:  
 MS-3A, PROJECTILE, PTT

N.E.W. 3.20 KG

## U.S.S.R. PROJECTILE, 120-MM, HE, MORTAR, OF-843

Ordnance used with:  
GVM, FUZE, PROJECTILE, PD  
GVMZ, FUZE, PROJECTILE, PD  
GVMZ-1, FUZE, PROJECTILE, PD  
GVMZ-7, PROJECTILE, PD  
M-1, PROJECTILE, PDSQ  
TYPE 1, PROJECTILE, PD  
M-12, FUZE, PROJECTILE, PD  
N.E.W. 2.68 KG

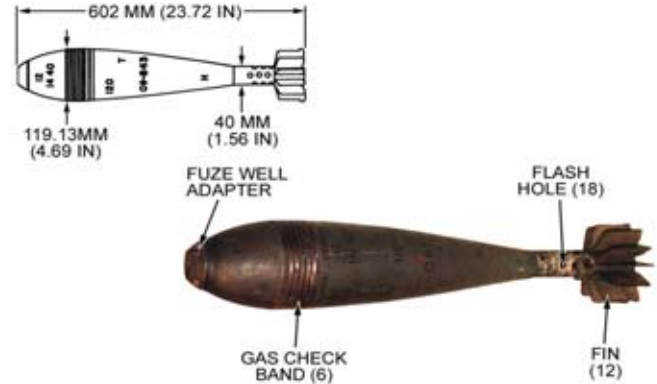

## U.S.S.R. PROJECTILE, 120-MM, MORTAR, SMOKE (WP) MODEL D-5

Ordnance used with:  
M-12, FUZE, PROJECTILE, PD  
M-4, PROJECTILE, PD

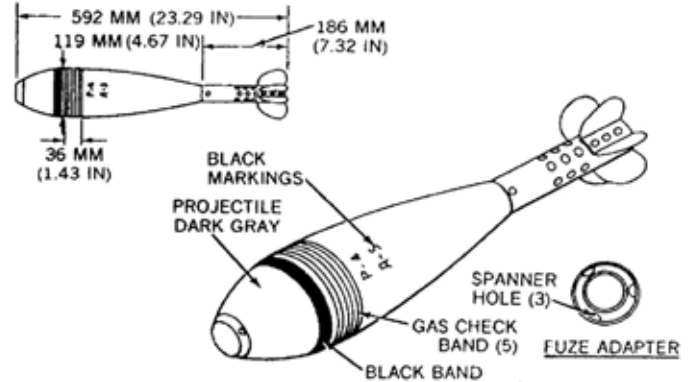

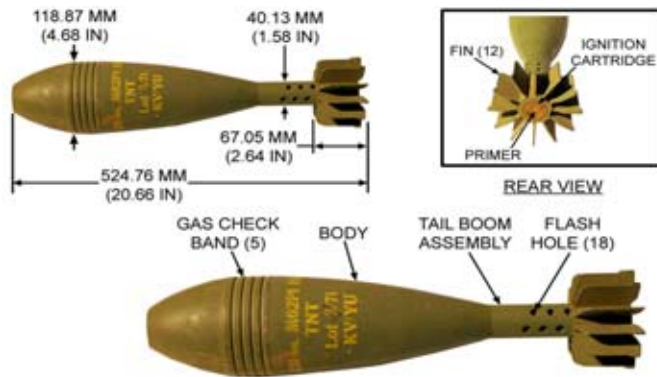

## YUGOSLAV PROJECTILE, 120-MM, HE, MORTAR, M62P1

Ordnance used with:  
 M62P1, CARTRIDGE, 120-MM, HE, MORTAR  
 UTU M45, PROJECTILE, PD  
 AUM-1, BOMB, NOSE  
 M-50, BOMB, NOSE  
 UTU M65, PROJECTILE, PD  
 UT M62P, PROJECTILE, PD

N.E.W. 2.52 KG



## CHINESE CARTRIDGE, 120-MM, HE, MORTAR, TYPE 55

Ordnance used with:  
 MP-71  
 MP71, PROJECTILE, PD  
 MP-8  
 MP8, PROJECTILE, PD  
 PAI-4, PROJECTILE, PD  
 TYPE PAI-4, PROJECTILE, PD  
 MP-4, PROJECTILE, PD

## CHINESE PROJECTILE, 120-MM, HE, MORTAR, TYPE 55

Ordnance used with:

MP-71

MP71, PROJECTILE, PD

MP-8

MP8, PROJECTILE, PD

PAI-4, PROJECTILE, PD

TYPE PAI-4, PROJECTILE, PD

MP-4, PROJECTILE, PD

N.E.W. 1.22 KG

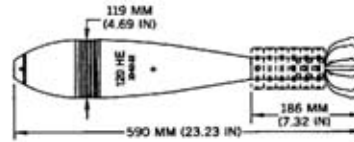

## FRENCH CARTRIDGE, 120-MM, DPICM, OGR 120 PR

Ordnance used with:

M 42, DP, SUBMUNITION



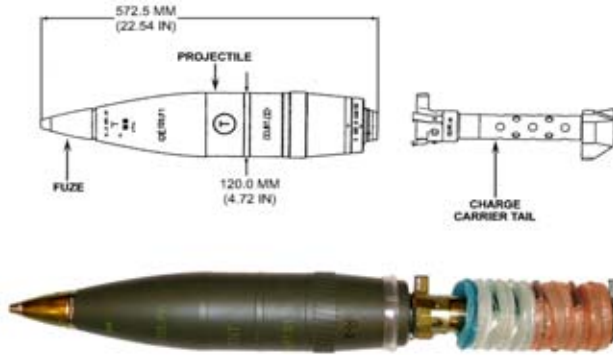

## FRENCH CARTRIDGE, 120-MM, HE, MORTAR, HE-120-PR

Ordnance used with:  
 M577, FUZE, PROJECTILE, MTSQ  
 M577A1, FUZE, PROJECTILE, MTSQ  
 M557C1, PROJECTILE, PD  
 FU RALEC 120 F4, PROJECTILE, PROX  
 HE-120-PR, 120MM, HE, MORTAR



## FRENCH CARTRIDGE, 120-MM, HE-MARKER, MORTAR, MK 44

Ordnance used with:  
 V.18.I, PROJECTILE, PD  
 V-19-P, PROJECTILE, PD  
 V19P, PROJECTILE, PD  
 V-18, PROJECTILE, PD  
 V19PA, PROJECTILE, PD

N.E.W. 2.50 KG



## FRENCH CARTRIDGE, 120-MM, HE-RA, MORTAR, PRPA

Ordnance used with:

M51A1, FUZE, PROJECTILE, PD  
M577, FUZE, PROJECTILE, MTSQ  
M577A1, FUZE, PROJECTILE, MTSQ  
M582, FUZE, PROJECTILE, MTSQ  
M582A1, FUZE, PROJECTILE, MTSQ  
F2

N.E.W. 4.87 KG

---



## FRENCH PROJECTILE, 120-MM, HE, MODEL 44

Ordnance used with:

V.18.I, PROJECTILE, PD

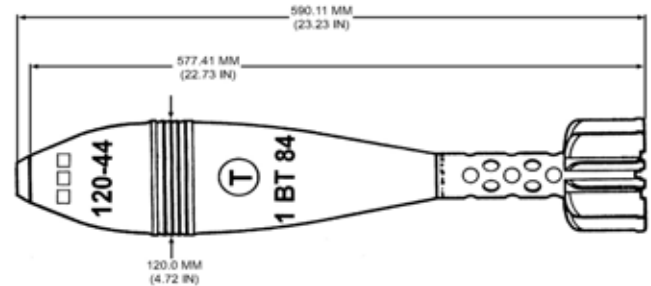

N.E.W. 2.68 KG

---

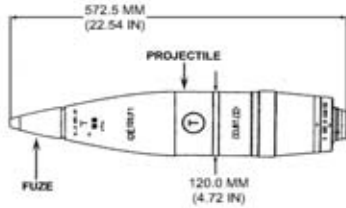

## FRENCH PROJECTILE, 120-MM, HE, MORTAR, HE-120-PR

Ordnance used with:  
 M577, FUZE, PROJECTILE, MTSQ  
 M577A1, FUZE, PROJECTILE, MTSQ  
 M557C1, PROJECTILE, PD  
 FU RALEC 120 F4, PROJECTILE, PROX  
 HE-120-PR, 120MM, CARTRIDGE, HE, MORTAR

N.E.W. 4.20 KG

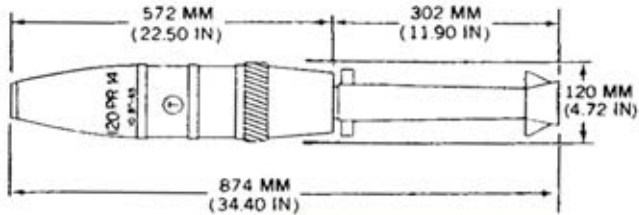

## FRENCH PROJECTILE, 120-MM, HE, MORTAR, MODEL PR 14

Ordnance used with:  
 M51, FUZE, PROJECTILE, PD  
 M51A1, FUZE, PROJECTILE,, PD  
 M51A2, FUZE, PROJECTILE, PD  
 M51A3, FUZE, PROJECTILE, PD  
 M51A4, FUZE, PROJECTILE, PD  
 M51A5, FUZE, PROJECTILE, PD  
 PF 120 PR 14, PROJECTILE, PROX

N.E.W. 4.20 KG

## FRENCH PROJECTILE, 120-MM, HE, MORTAR, OE.120.F1

Ordnance used with:  
M557, FUZE, PROJECTILE, PD  
VG-29, PROJECTILE, PD  
OE 120 F1, 120MM, CARTRIDGE, HE, MORTAR

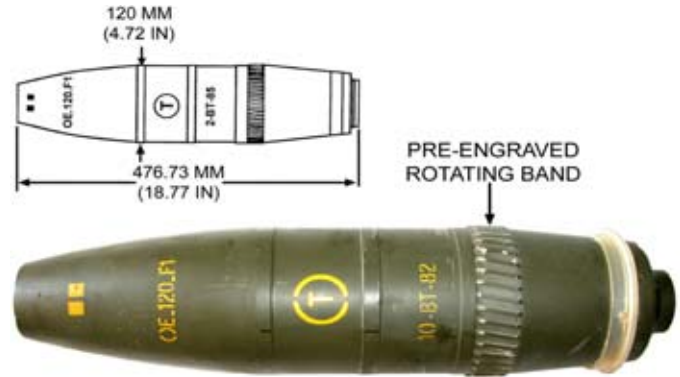

## FRENCH PROJECTILE, 120-MM, HE, MORTAR, P.R.P.A.

Ordnance used with:  
M51A1, FUZE, PROJECTILE., PD  
M577, FUZE, PROJECTILE, MTSQ  
M577A1, FUZE, PROJECTILE, MTSQ  
M582, FUZE, PROJECTILE, MTSQ  
M582A1, FUZE, PROJECTILE, MTSQ  
VG-29, PROJECTILE, PD

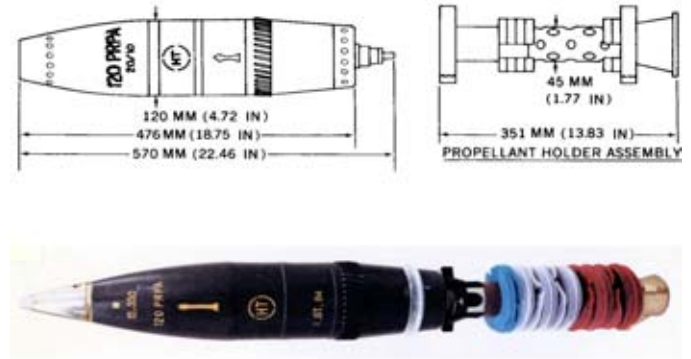

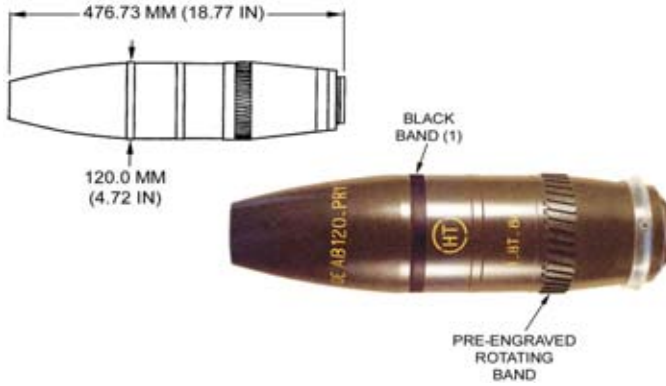

## FRENCH PROJECTILE, 120-MM, HE, MORTAR, PR AB

Ordnance used with:  
 OE AB120\_PRY  
 PR AB, CARTRIDGE, 120-MM, HE  
 VG-29-A, PROJECTILE, PD

N.E.W. 4.45 KG

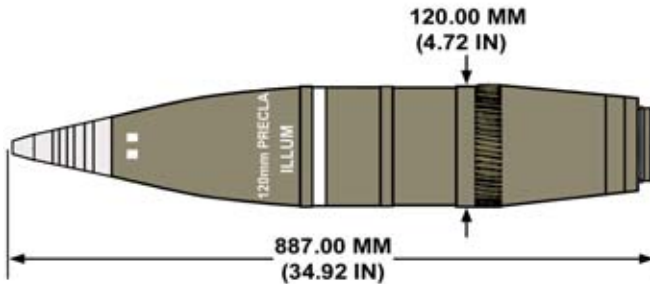

## FRENCH PROJECTILE, 120-MM, ILLUM, MORTAR, PRECLAIR

Ordnance used with:  
 FR 55A, PROJECTILE, MT

## FRENCH PROJECTILE, 120-MM, MORTAR, ILLUMINATION, PR M

Ordnance used with:  
FR55B, PROJECTILE, MT

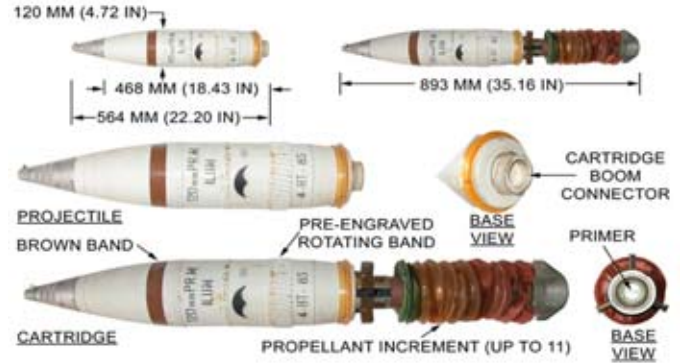

## FRENCH PROJECTILE, 120-MM, SMOKE, MORTAR, 120-PR

Ordnance used with:  
M557, FUZE, PROJECTILE, PD

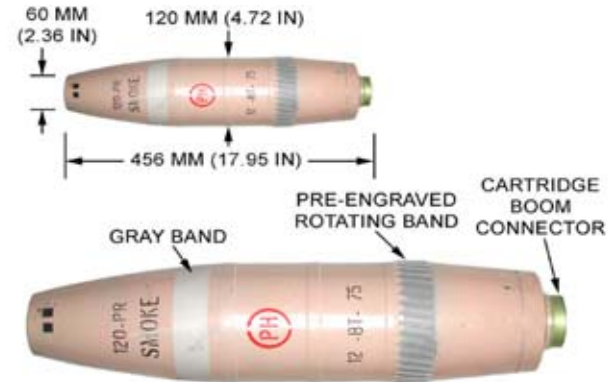

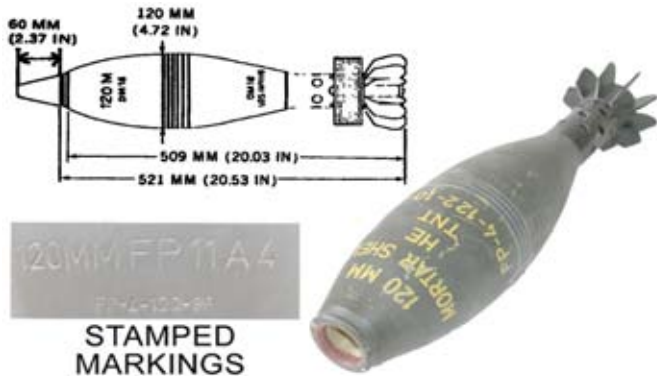

**GERMAN (FEDERAL REPUBLIC) PROJECTILE, 120-MM, MORTAR, HE, MODEL DM11A4; FP11A4**

Ordnance used with:  
 NVT- 24, PROJECTILE, PROXIMITY  
 DM 111, PROJECTILE, PD  
 AZ DM11A1, PROJECTILE, PD  
 DM 111A1, PROJECTILE, PD  
 AZ 111 A2  
 AZ DM 111A2, PD  
 DM 111A2, PROJECTILE, PD

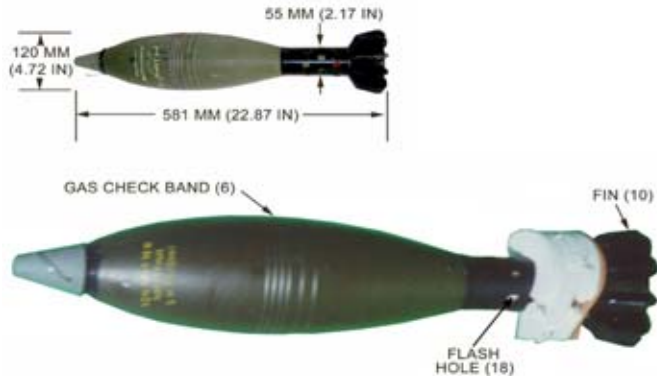

**IRANIAN CARTRIDGE, 120-MM, HE, MORTAR, MODEL UNKNOWN**

Ordnance used with:  
 AZ111 A2, PROJECTILE, PD  
 AZ111-A2  
 AZ111, PROJECTILE, PD  
 DM111, PROJECTILE, PD  
 UNKNOWN, 120MM, MORTAR, HE

**IRANIAN PROJECTILE, 120-MM, HE, MODEL UNKNOWN**

Ordnance used with:  
 B335, PROJECTILE, PD  
 PDB 335, PROJECTILE, PD  
 MP-7A  
 MP7A, PROJECTILE, PD  
 MODEL UNKNOWN, 120-MM, MORTAR, CARTRIDGE, HE

N.E.W. 2.09 KG

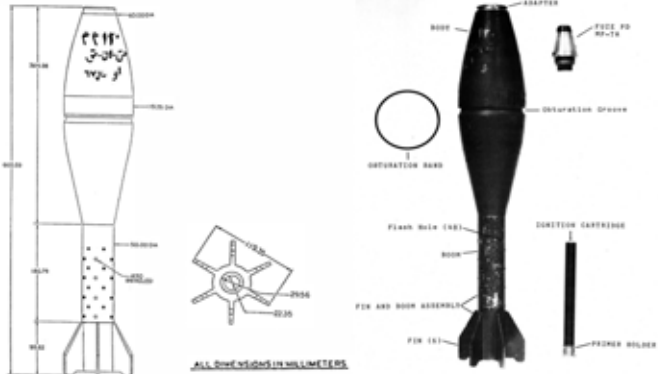

**IRANIAN PROJECTILE, 120-MM, HE, MORTAR, MODEL UNKNOWN**

Ordnance used with:  
 UNKNOWN, 120MM, MORTAR, HE

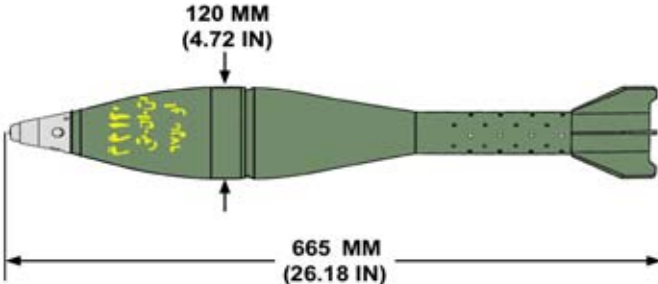

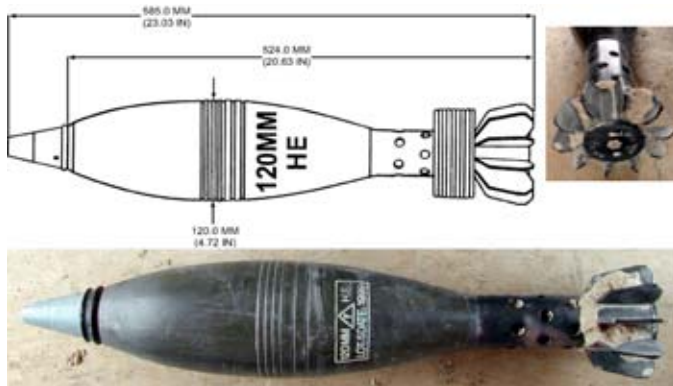

**IRANIAN PROJECTILE, 120-MM, HE, MORTAR, MODEL UNKNOWN**

Ordnance used with:  
 AZ111 A2, PROJECTILE, PD  
 AZ111-A2  
 AZ111, PROJECTILE, PD  
 DM111, PROJECTILE, PD  
 UNKNOWN, 120MM, CARTRIDGE, HE, MORTAR

N.E.W. 2.30 KG



**ITALIAN CARTRIDGE, 120-MM, HE, MORTAR, 120L**

Ordnance used with:  
 V-19-P, PROJECTILE, PD  
 V19P, PROJECTILE, PD



## SINGAPORE PROJECTILE, 120-MM, MORTAR, HE, MODEL UNKNOWN

Ordnance used with:  
AZ DM111A1, PROJECTILE, PD  
DM 111A1, PROJECTILE, PD  
EF-722 (NOVA), PROJECTILE, PROXIMITY/PD

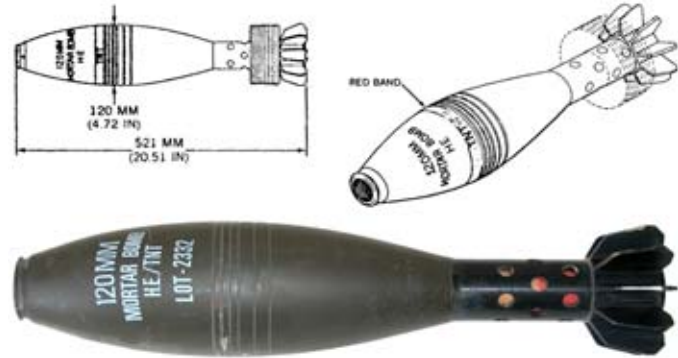

N.E.W. 2.30 KG

## SPANISH PROJECTILE, 120-MM, MORTAR, ILLUMINATION, M-847

Ordnance used with:  
ECIA M-84, PROJECTILE, TIME

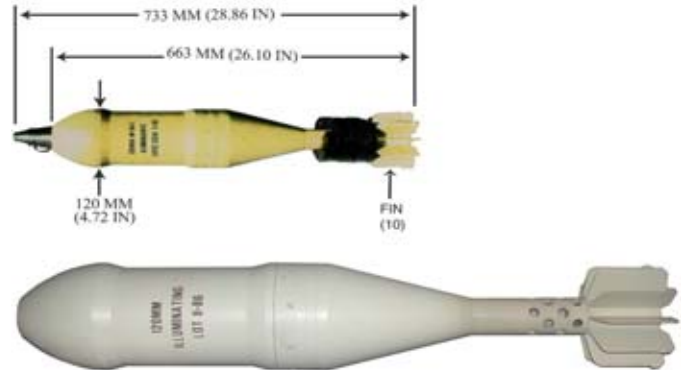

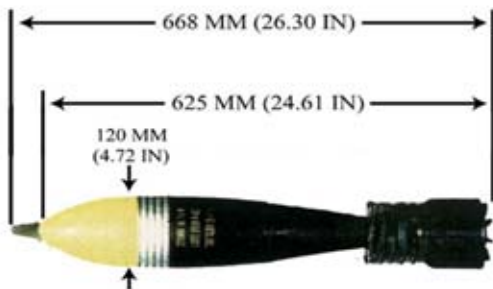

## SPANISH PROJECTILE, 120-MM, MORTAR, SMOKE, M-75-N

Ordnance used with:  
M-55, PROJECTILE, PD

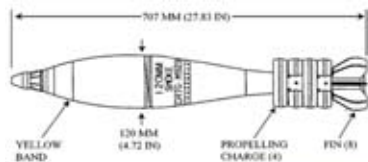

## U.S. CARTRIDGE, 120-MM, SMOKE, WP, M929

Ordnance used with:  
M564, FUZE, PROJECTILE, MTSQ  
M734A1, PROJECTILE, MULTIOPTION  
M745, PROJECTILE, PD  
XM745, PROJECTILE, PD



N.E.W. 2.20 OZ

## U.S.S.R. CARTRIDGE, 120-MM, MORTAR, ILLUM, S-843

Ordnance used with:  
S-843, 120-MM, MORTAR, ILLUMINATION  
T-1, PROJECTILE, TSQ

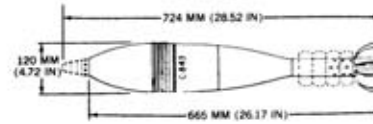

N.E.W. 367.00 G

## U.S.S.R. PROJECTILE, 115-MM, HVAP-FS-DS-T MODEL BM-6

Ordnance used with:  
UBM-5, 115MM, CARTRIDGE, APFSDS-T

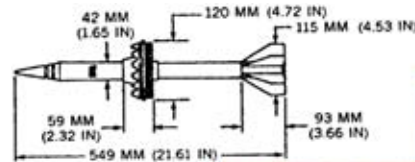

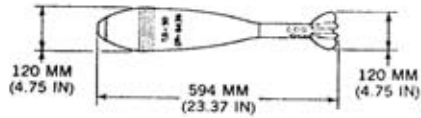

### U.S.S.R. PROJECTILE, 120-MM, HE, MORTAR, MODEL OF-843B

Ordnance used with:

GVMZ-7, PROJECTILE, PD

M-12, FUZE, PROJECTILE, PD

V-22, FUZE, PROJECTILE, PD

MP-4, PROJECTILE, PD

MP4, PROJECTILE, PD

M-12 (MODIFIED), PROJECTILE, PD

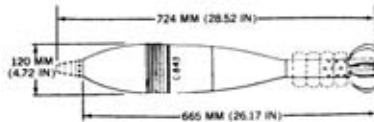

### U.S.S.R. PROJECTILE, 120-MM, MORTAR, ILLUM, MODEL S-843

Ordnance used with:

T-1, PROJECTILE, TSQ

S-843, 120-MM, MORTAR, CARTRIDGE, ILLUMINATION



## YUGOSLAV CARTRIDGE, 120-MM, MORTAR, SMOKE (WP), M64P1

Ordnance used with:  
M64P1, 120 MM, SMOKE WP, MORTAR  
UT M70P1, PROJECTILE, PD  
UT,M70 P1, PROJECTILE, PD

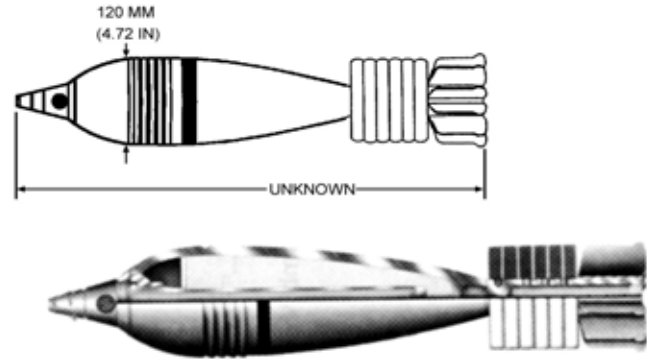

## YUGOSLAV CARTRIDGE, 120-MM, SMOKE, MORTAR, M84

Ordnance used with:  
TP M66 , PROJECTILE, PTT  
M84, PROJECTILE, PTT  
M84, 120-MM, SMOKE, MORTAR



## YUGOSLAV MORTAR, 120-MM, SMOKE, HC, M88

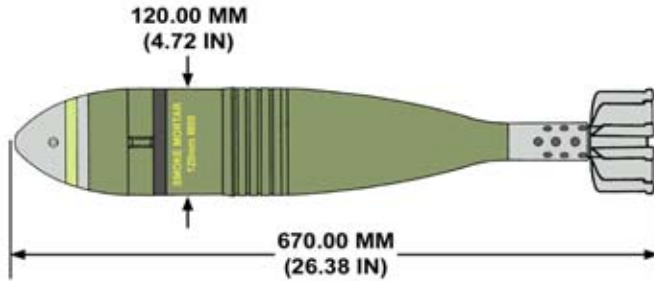

Ordnance used with:  
M84, PROJECTILE, PTT

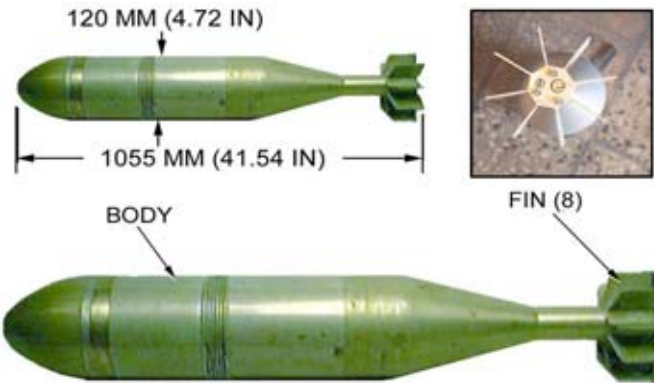

## YUGOSLAV PROJECTILE, 120-MM, DUMMY PARACHUTIST, MODEL UNKNOWN

## YUGOSLAV PROJECTILE, 120-MM, HE, MORTAR, M62P3

Ordnance used with:  
AU-29, PROJECTILE, PD  
UTU M78, PROJECTILE, PD  
UT M68 P1, PROJECTILE, PD  
UT M68P1, PROJECTILE, PD  
UT.M68 P1, PROJECTILE, PD  
MU K92, PROJECTILE, PD  
UT M93, PROJECTILE, PD

N.E.W. 2.30 KG

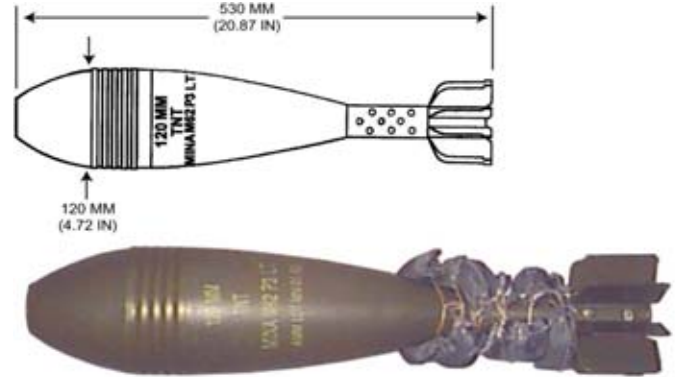

## YUGOSLAV PROJECTILE, 120-MM, HERA, FRAG, M77

Ordnance used with:  
AU-29, PROJECTILE, PD  
UTU M78, PROJECTILE, PD  
M77, 120-MM, CARTRIDGE, MORTAR, HERA, FRAG

N.E.W. 2.90 KG

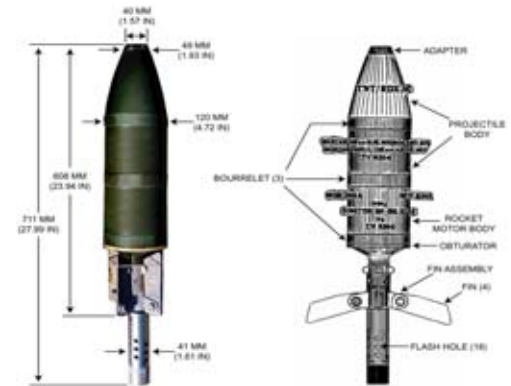

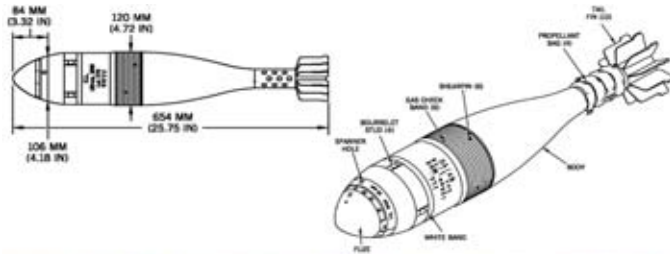

**YUGOSLAV PROJECTILE, 120-MM, MORTAR, ILLUMINATION, M66**

Ordnance used with:  
 M66, 120-MM, CARTRIDGE, ILLUMINATION, MORTAR  
 TP M66 , PROJECTILE, PTT  
 M66, 120-MM, ILLUM, MORTAR



N.E.W. 16.00 G

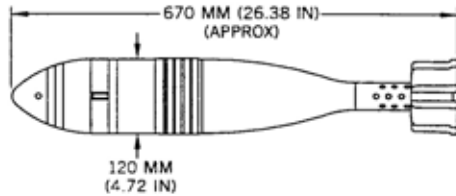

**YUGOSLAV PROJECTILE, 120-MM, MORTAR, ILLUMINATION, M84**

Ordnance used with:  
 M84, PROJECTILE, PTT

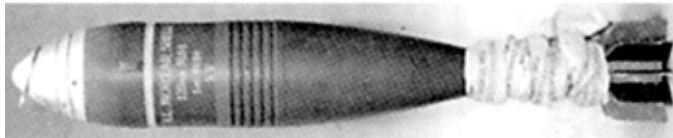



## YUGOSLAV PROJECTILE, 120-MM, MORTAR, SMOKE (WP), M64P1

Ordnance used with:  
UT M70P1, PROJECTILE, PD  
UT,M70 P1, PROJECTILE, PD  
M64P1, CARTRIDGE, 120 MM, SMOKE, WP, MORTAR  
UT M62P, PROJECTILE, PD

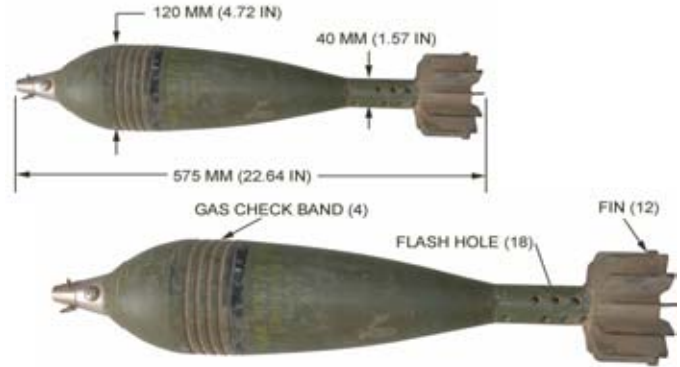

## U.S.S.R. PROJECTILE, 122-MM, SMOKE, WP, MODEL D-4

Ordnance used with:  
RGM-2, PROJECTILE, PD  
RGM-3, PROJECTILE, PD  
ZH10, 122MM, PROPELLING CHARGE, REDUCED  
ZH-9, 122 MM, PROPELLING CHARGE  
ZH-9, 122MM, PROPELLING CHARGE, FULL

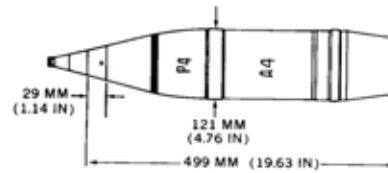

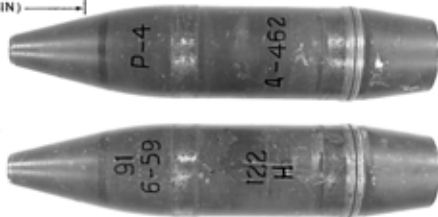
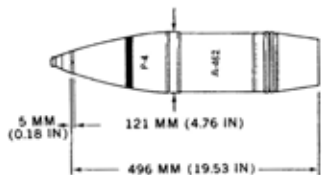

## U.S.S.R. PROJECTILE, 122-MM, SMOKE, WP, MODEL D-462

Ordnance used with:  
 KT-1, FUZE, PROJECTILE, PD  
 KT-2, FUZE, PROJECTILE, PD  
 KT-3, FUZE, PROJECTILE, PD  
 KTM-1, PROJECTILE, PD  
 KTM-1U, PROJECTILE, PD  
 KTM-1Y, PROJECTILE, PD  
 KTM-2, PROJECTILE, PD

N.E.W. 158.00 G



## BULGARIAN PROJECTILE, HE, FE-462

Ordnance used with:  
 RGM-2, PROJECTILE, PD

## CHINESE PROJECTILE, 122-MM, FRAG-HE, TYPE 462

Ordnance used with:  
TYPE 3, PIBD  
TYPE 3, PIBD, SELF-DESTRUCT (SD)

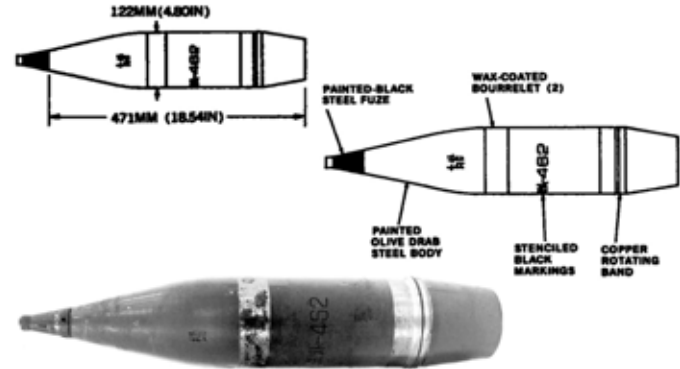

## CHINESE PROJECTILE, 122-MM, HE, TYPE 54

Ordnance used with:  
DRL08, PROJECTILE, PDSQ  
MD-82  
MD82, PROJECTILE, PROXIMITY  
ML-4  
ML4, PROJECTILE, PD  
ML-5  
ML5, PROJECTILE, PD  
N.E.W. 4.30 KG

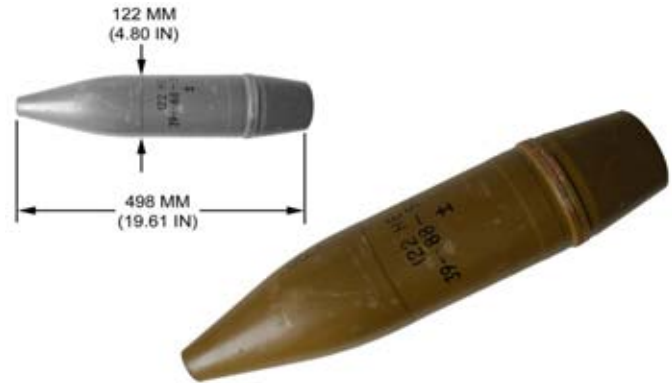

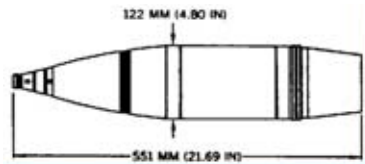

**CHINESE PROJECTILE, 122-MM, SMOKE, TYPE 54**

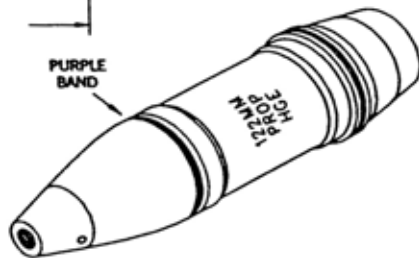
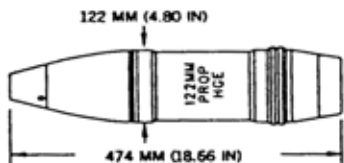

**IRAQI PROJECTILE, 122 MM, PROPAGANDA, MODEL UNKNOWN**

Ordnance used with:  
T-90, PROJECTILE, MT  
B-90, PROJECTILE, MTSQ  
V-90, PROJECTILE, MTSQ

## IRAQI PROJECTILE, 122-MM, HE, HGC

Ordnance used with:  
HGC, 122MM, PROPELLING CHARGE, REDUCED  
HGC, 122MM, PROPELLING CHARGE, FULL



## IRAQI PROJECTILE, 122-MM, HE, HGE

Ordnance used with:  
ZH-9, 122 MM, PROPELLING CHARGE  
ZH-9, 122MM, PROPELLING CHARGE, FULL  
HGC, 122MM, PROPELLING CHARGE, REDUCED  
HGC, 122MM, PROPELLING CHARGE, FULL

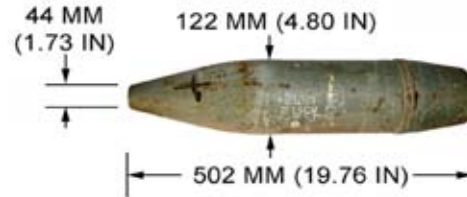

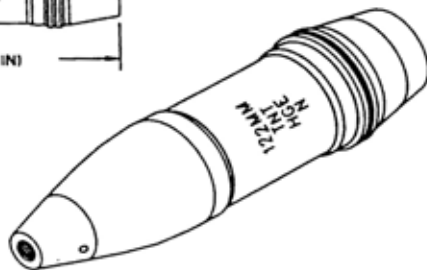
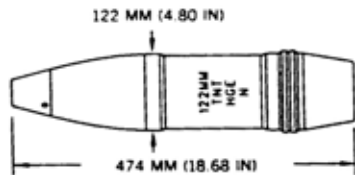

## IRAQI PROJECTILE, 122-MM, HE, MODEL UNKNOWN

N.E.W. 3.00 KG

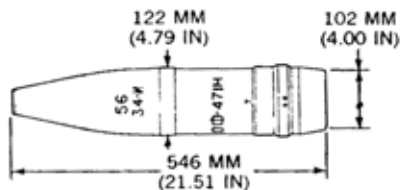

## U.S.S.R. PROJECTILE, 122-MM, FRAG, HE, MODEL OF-471N

Ordnance used with:  
 D-1, PROJECTILE, TSQ  
 RGM, PROJECTILE, PD  
 RGM-2, PROJECTILE, PD  
 RGM-3, PROJECTILE, PD  
 RGM-6, PROJECTILE, PD  
 AR 7 (SIGNAL), PROJECTILE, PROXIMITY/PD  
 V-429, PROJECTILE, PD

## U.S.S.R. PROJECTILE, 122-MM, FRAG, HE, MODEL OF-471N (VARIANT)

Ordnance used with:  
D-1, PROJECTILE, TSQ  
RGM, PROJECTILE, PD  
RGM-2, PROJECTILE, PD  
RGM-3, PROJECTILE, PD  
RGM-6, PROJECTILE, PD  
AR 7 (SIGNAL), PROJECTILE, PROXIMITY/PD

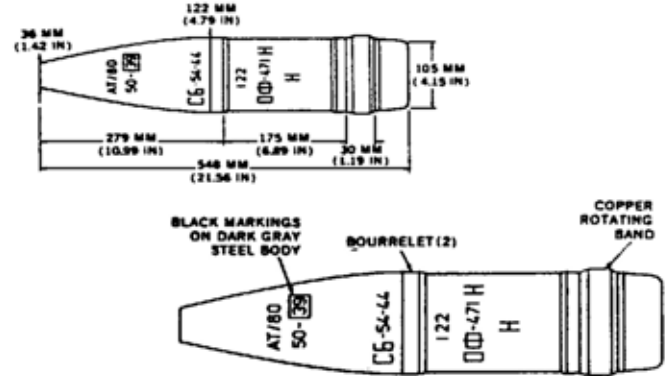

## U.S.S.R. PROJECTILE, 122-MM, HE, FRAG, MODEL OF-462

Ordnance used with:  
D-1, PROJECTILE, TSQ  
GVM, FUZE, PROJECTILE, PD  
GVMZ, FUZE, PROJECTILE, PD  
GVMZ-1, FUZE, PROJECTILE, PD  
RG-6, PROJECTILE, PD  
RGM, PROJECTILE, PD  
RGM-2, PROJECTILE, PD

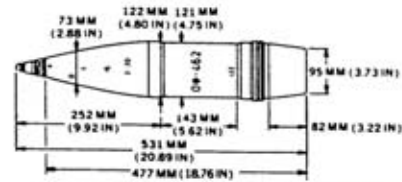

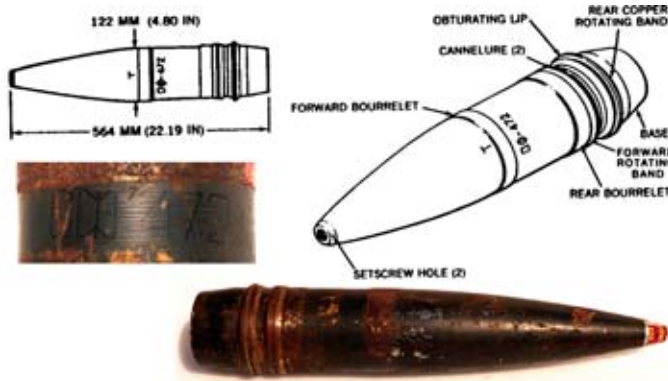

## U.S.S.R. PROJECTILE, 122-MM, HE, FRAG, MODEL OF-472

Ordnance used with:  
 D-1, PROJECTILE, TSQ  
 RGM-2, PROJECTILE, PD  
 RGM-6, PROJECTILE, PD  
 AR 7 (SIGNAL), PROJECTILE, PROXIMITY/PD  
 V-429, PROJECTILE, PD  
 V-429E, PROJECTILE, PD  
 VOF-471, CARTRIDGE, 122MM, HE  
 N.E.W. 3.00 KG

## U.S.S.R. PROJECTILE, 122-MM, HE, OF-1

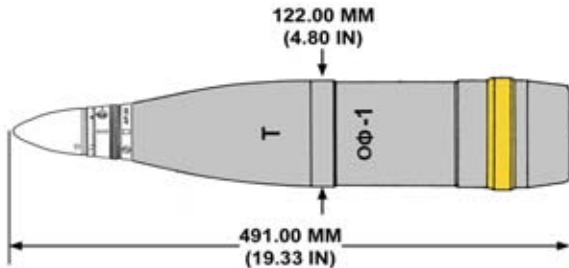

Ordnance used with:  
 AR 30, PROJECTILE, PROXIMITY  
 AR-30, PROJECTILE, PROXIMITY

N.E.W. 2.77 KG



## U.S.S.R. PROJECTILE, 122-MM, HE, OF-462ZH

Ordnance used with:  
RGM, PROJECTILE, PD  
RGM-2, PROJECTILE, PD  
RGM-3, PROJECTILE, PD

N.E.W. 3.46 KG

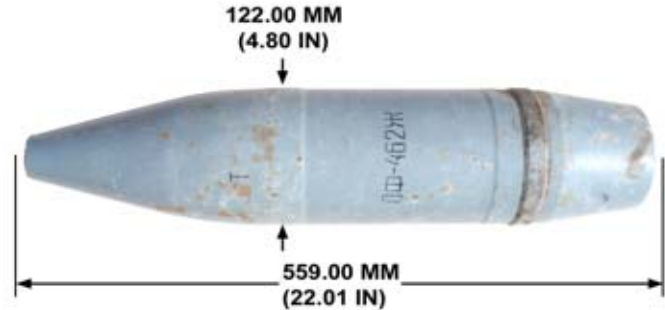

## U.S.S.R. PROJECTILE, 122-MM, HE, OF-56

Ordnance used with:  
PF 122, PROJECTILE, PROXIMITY/PD  
PF-122, PROJECTILE, PROXIMITY/PD  
PF122, PROJECTILE, PROXIMITY/PD  
D-1, PROJECTILE, TSQ  
RGM-2, PROJECTILE, PD  
RGM-2M, PROJECTILE, PD  
RGM-3, PROJECTILE, PD

N.E.W. 4.40 KG

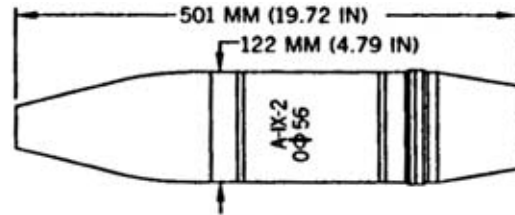

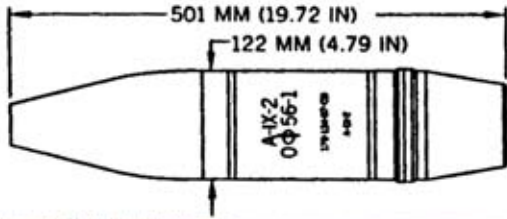

## U.S.S.R. PROJECTILE, 122-MM, HE, OF-56-1

Ordnance used with:

PF 122, PROJECTILE, PROXIMITY/PD  
 PF-122, PROJECTILE, PROXIMITY/PD  
 PF122, PROJECTILE, PROXIMITY/PD  
 D-1, PROJECTILE, TSQ  
 RGM-2, PROJECTILE, PD  
 RGM-2M, PROJECTILE, PD  
 RGM-3, PROJECTILE, PD

N.E.W. 4.40 KG



## U.S.S.R. PROJECTILE, 122-MM, HE-FRAG, OF-462 (WITHOUT ADAPTER)

Ordnance used with:

PF 122, PROJECTILE, PROXIMITY/PD  
 PF-122, PROJECTILE, PROXIMITY/PD  
 PF122, PROJECTILE, PROXIMITY/PD  
 ZH-9, 122 MM, PROPELLING CHARGE  
 ZH-9, 122MM, PROPELLING CHARGE, FULL

N.E.W. 3.46 KG

## U.S.S.R. PROJECTILE, 122-MM, HEAT, BK-9

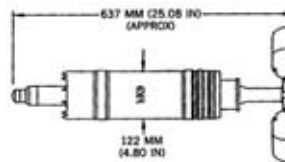

N.E.W. 1.96 KG

## U.S.S.R. PROJECTILE, 122-MM, HEAT, SPIN-STABILIZED, MODEL BP-463

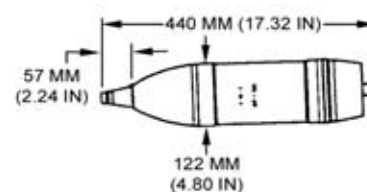

Ordnance used with:  
GKV, PROJECTILE, PIBD  
MP, PROJECTILE, PD  
MP-82, PROJECTILE, PD



N.E.W. 2.18 KG

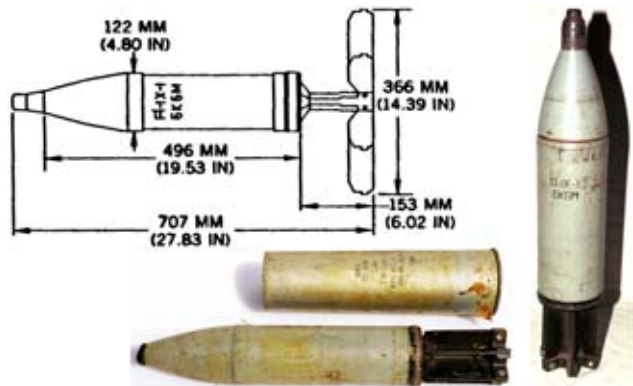

### U.S.S.R. PROJECTILE, 122-MM, HEAT-FS, BK-6M

Ordnance used with:  
 GPV-2, PROJECTILE, PIBD, SPITBACK  
 ZH-9, 122 MM, PROPELLING CHARGE  
 ZH-9, 122MM, PROPELLING CHARGE, FULL

N.E.W. 2.30 KG

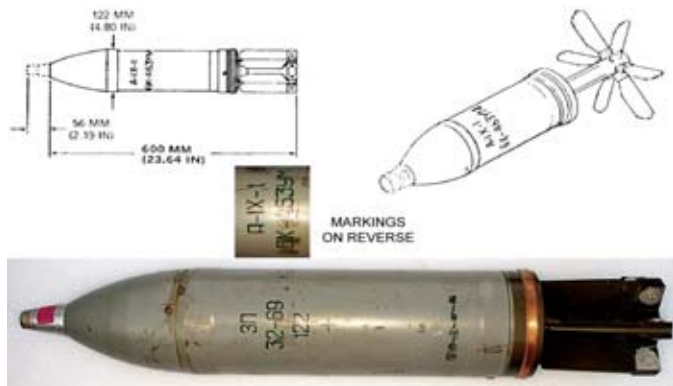

### U.S.S.R. PROJECTILE, 122-MM, HEAT-FS, MODEL BK463UM

Ordnance used with:  
 GPV-2, PROJECTILE, PIBD, SPITBACK

N.E.W. 2.12 KG

## U.S.S.R. PROJECTILE, 122-MM, ILLUM, S-463 & S-463ZH

Ordnance used with:  
T-6, FUZE, PROJECTILE, TSQ  
T-7, FUZE, PROJECTILE, TIME OR TSQ  
T-90, PROJECTILE, MT  
ZH-9, 122 MM, PROPELLING CHARGE  
ZH-9, 122MM, PROPELLING CHARGE, FULL

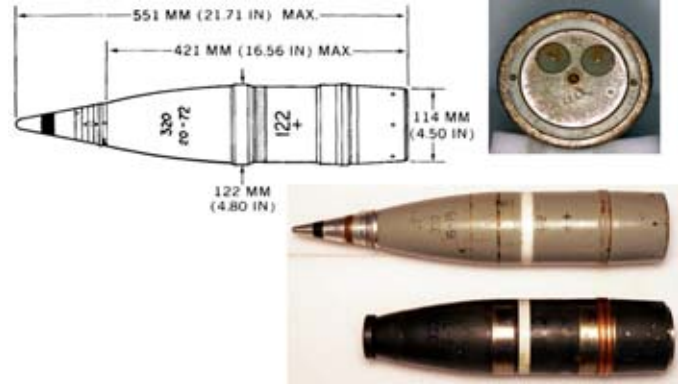

## YUGOSLAV CARTRIDGE, 122-MM, HE, 462

Ordnance used with:  
M557, FUZE, PROJECTILE, PD  
M572, FUZE, PROJECTILE, PD  
RGM-2, PROJECTILE, PD  
RGM-3, PROJECTILE, PD  
AU-18P1, PROJECTILE, PD  
UTIU M72, PROJECTILE, PD  
AU-10, PROJECTILE, PF

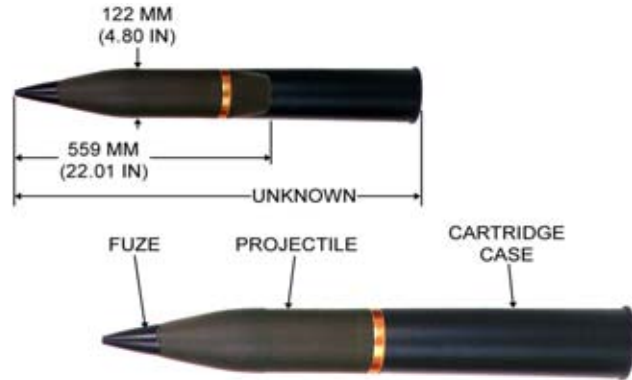



## YUGOSLAV PROJECTILE, 122-MM, HE, 462

Ordnance used with:  
 M557, FUZE, PROJECTILE, PD  
 M572, FUZE, PROJECTILE, PD  
 RGM-2, PROJECTILE, PD  
 AU-18P1, PROJECTILE, PD  
 UTIU M72, PROJECTILE, PD  
 AU-10, PROJECTILE, PF  
 UTU M557, PROJECTILE, PD

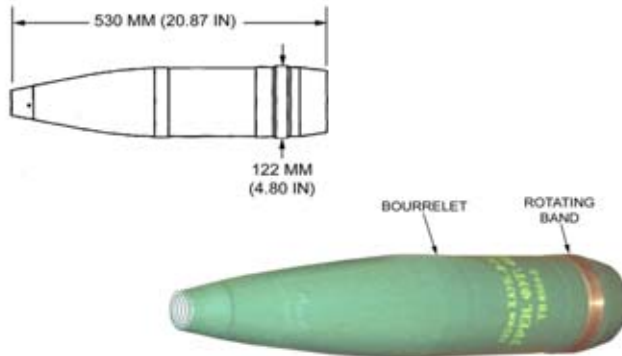

## YUGOSLAV PROJECTILE, 122-MM, HE, M76

Ordnance used with:  
 RGM-2, PROJECTILE, PD  
 RGM-3, PROJECTILE, PD  
 V-429, PROJECTILE, PD  
 V-429E, PROJECTILE, PD  
 MODEL UNKNOWN, CARTRIDGE, 122-MM, HE, (WITH M76)

## U.S.S.R. PROJECTILE, 122-MM, HEAT-FS, MODEL BK 13

Ordnance used with:  
V-15, FUZE, PROJECTILE, PIBD  
3UBK-9, 122-MM, CARTRIDGE, HEAT-FS-T  
VBK9

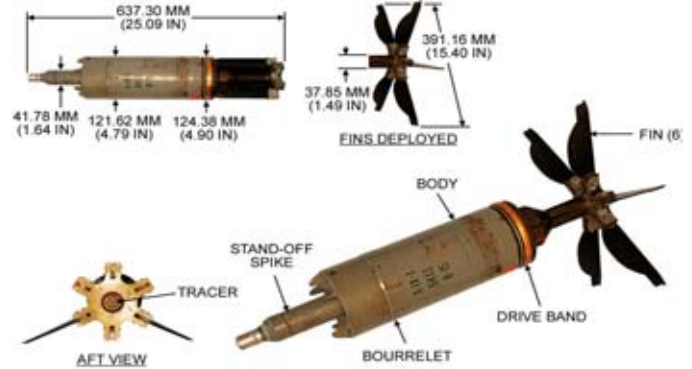

N.E.W. 1.81 KG

## U.S.S.R. CARTRIDGE, 125-MM, APFSDS-T, VBM-7

Ordnance used with:  
BM-15, 125-MM, APFSDS-T  
ZH-40, 125MM, PROPELLING CHARGE  
ZH-52, 125MM, PROPELLING CHARGE

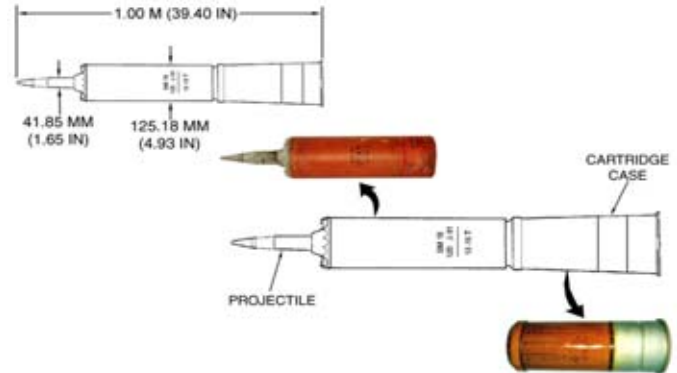

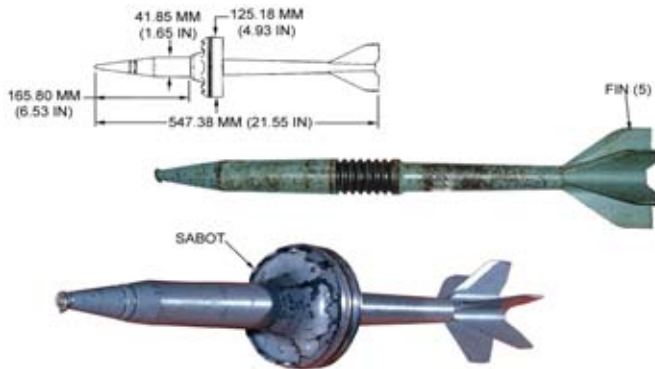

## U.S.S.R. PROJECTILE, 125-MM, APFSDS-T, BM-15

Ordnance used with:  
 BM-18, 125MM, APFSDS-T  
 VBM-7, 125-MM, CARTRIDGE, APFSDS-T  
 ZH-40, 125MM, PROPELLING CHARGE  
 ZH-52, 125MM, PROPELLING CHARGE

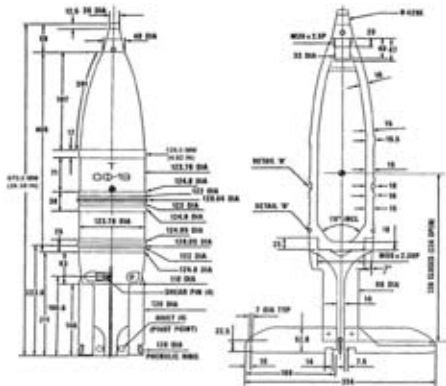

## U.S.S.R. PROJECTILE, 125-MM, HE-FRAG, MODEL OF-19

Ordnance used with:  
 V-429E, PROJECTILE, PD  
 VS-5, PROJECTILE, PD  
 ZH-40, 125MM, PROPELLING CHARGE  
 VOF-22, CARTRIDGE, 125MM, HE

N.E.W. 3.15 KG



## U.S.S.R. PROJECTILE, 125-MM, HE-FRAG, OF-26

Ordnance used with:  
V-429E, PROJECTILE, PD  
3VOF36, CARTRIDGE, 125MM, HE  
VOF-36  
ZH-52, 125MM, PROPELLING CHARGE

N.E.W. 3.30 KG

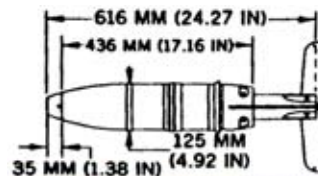

## U.S.S.R. PROJECTILE, 125-MM, HEAT, 3BK29

Ordnance used with:  
VU-729, PROJECTILE, PIBD  
VBK-25, CARTRIDGE, 125MM, HEAT

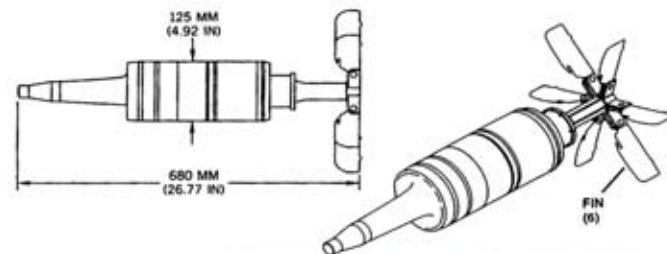

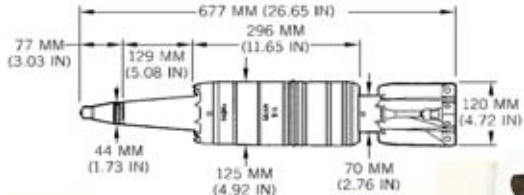

## U.S.S.R. PROJECTILE, 125-MM, HEAT-T, BK-14M

Ordnance used with:  
 V-15, FUZE, PROJECTILE, PIBD  
 VBK-10, 125MM, CARTRIDGE, HEAT  
 ZH-40, 125MM, PROPELLING CHARGE  
 ZH-52, 125MM, PROPELLING CHARGE

N.E.W. 1.85 KG

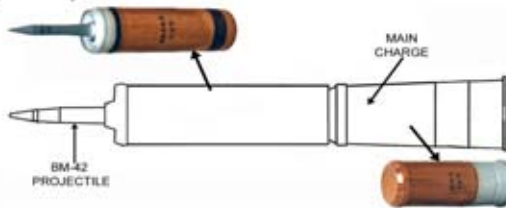
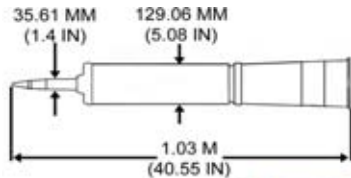

## U.S.S.R. CARTRIDGE, 125-MM, APFSDS-T, VBM-17

Ordnance used with:  
 BM-42, 125-MM, APFSDS-T  
 4ZH-63, 125MM, PROPELLING CHARGE  
 VBM-17M, CARTRIDGE, 125-MM, APFSDS  
 ZH-63, 125MM, PROPELLING CHARGE

## U.S.S.R. PROJECTILE, 125-MM, APFSDS-T, BM-42

Ordnance used with:

BM44, 125MM, APFSDS-T, PROPELLING CHARGE, AUXILIARY  
VBM-17, CARTRIDGE, 125-MM, APFSDS  
ZBM44, 125MM, APFSDS-T, PROPELLING CHARGE, AUXILIARY  
4ZH-63, 125MM, PROPELLING CHARGE  
VBM-17M, CARTRIDGE, 125-MM, APFSDS  
ZH-63, 125MM, PROPELLING CHARGE

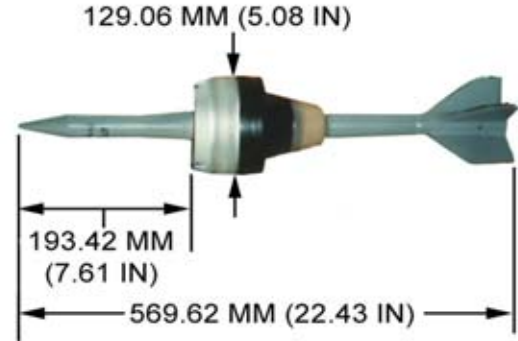

## CHINESE PROJECTILE, 130-MM, HE, AND HEI, TYPE 59

Ordnance used with:

TYPE 59, 130MM, PROPELLING CHARGE, REDUCED VARIABLE  
ZH 482U, 130MM, PROPELLING CHARGE, REDUCED  
MD-11  
MD11, PROJECTILE, PROXIMITY/PD  
MD-81  
MD81, PROJECTILE, PROXIMITY  
MD-11A, PROJECTILE, PROXIMITY/PD  
N.E.W. 3.64 KG

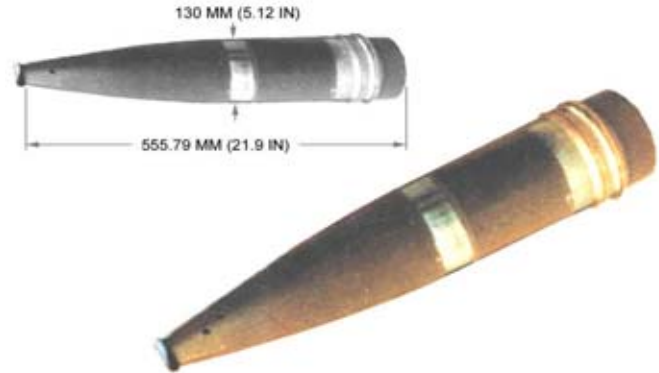

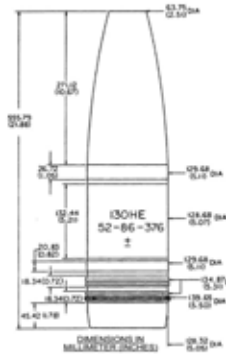

## CHINESE PROJECTILE, 130-MM, HE, TYPE 59 MODIFIED



Ordnance used with:

TYPE 59, 130MM, PROPELLING CHARGE, REDUCED VARIABLE

ZH 482U, 130MM, PROPELLING CHARGE, REDUCED

MD-11

MD11, PROJECTILE, PROXIMITY/PD

MD-81

MD81, PROJECTILE, PROXIMITY

MD-11A, PROJECTILE, PROXIMITY/PD

N.E.W. 1.85 KG

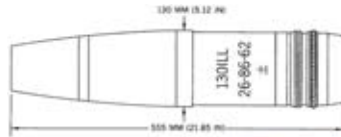

## CHINESE PROJECTILE, 130-MM, ILLUMINATION, TYPE 59



Ordnance used with:

TYPE 59, 130MM, PROPELLING CHARGE, REDUCED VARIABLE

ZH 482U, 130MM, PROPELLING CHARGE, REDUCED

MS-1

MS1, PROJECTILE, MT

M-1954, 130MM, FIELD GUN

M46, 130MM, FIELD GUN

TYPE 59, 130MM, FIELD GUN

N.E.W. 2.95 KG



## CHINESE PROJECTILE, 130-MM, SMOKE, TYPE 59

Ordnance used with:  
TYPE 59, 130MM, PROPELLING CHARGE, REDUCED VARIABLE  
ZH 482U, 130MM, PROPELLING CHARGE, REDUCED  
ML-5  
ML5, PROJECTILE, PD  
M-1954, 130MM, FIELD GUN  
M46, 130MM, FIELD GUN  
TYPE 59, 130MM, FIELD GUN

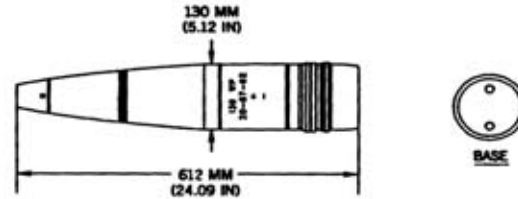

## CHINESE PROJECTILE, 130-MM, SMOKE, TYPE 59-1

Ordnance used with:  
TYPE 59, 130MM, PROPELLING CHARGE, REDUCED VARIABLE  
ZH 482U, 130MM, PROPELLING CHARGE, REDUCED  
M-1954, 130MM, FIELD GUN  
M46, 130MM, FIELD GUN  
TYPE 59, 130MM, FIELD GUN  
TYPE 59-1, 130MM, FIELD GUN  
SHF-1, PROJECTILE, MT

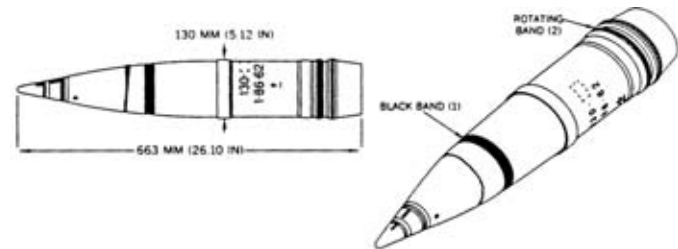

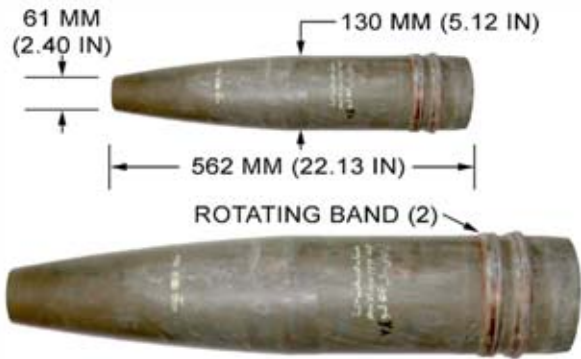

**IRANIAN PROJECTILE, 130-MM, HE, MODEL UNKNOWN**

Ordnance used with:  
M572, PROJECTILE, PD

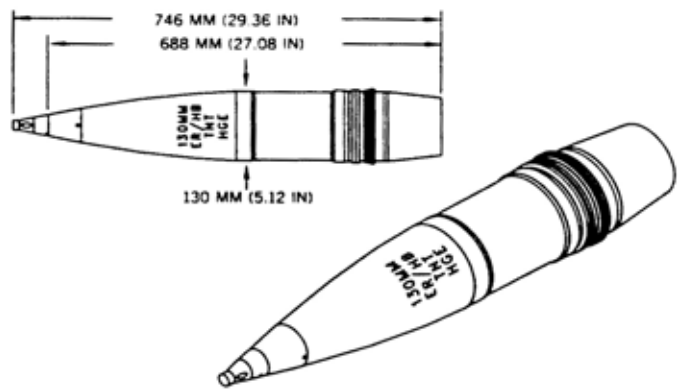

**IRAQI PROJECTILE, 130-MM, HE, (ER/HB), MODEL UNKNOWN**

Ordnance used with:  
V-429, PROJECTILE, PD  
V-429E, PROJECTILE, PD  
B-90, PROJECTILE, MTSQ  
V-90, PROJECTILE, MTSQ

N.E.W. 3.60 KG

## IRAQI PROJECTILE, 130-MM, HE, HE482M

Ordnance used with:  
HGC, 130-MM, PROPELLING CHARGE, REDUCED

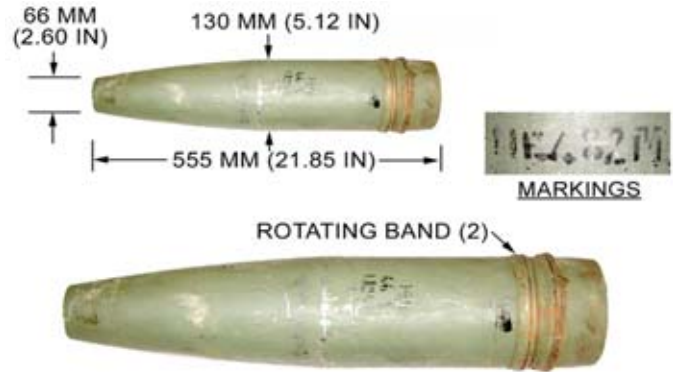

## IRAQI PROJECTILE, 130-MM, SMOKE, (WP), MODEL UNKNOWN

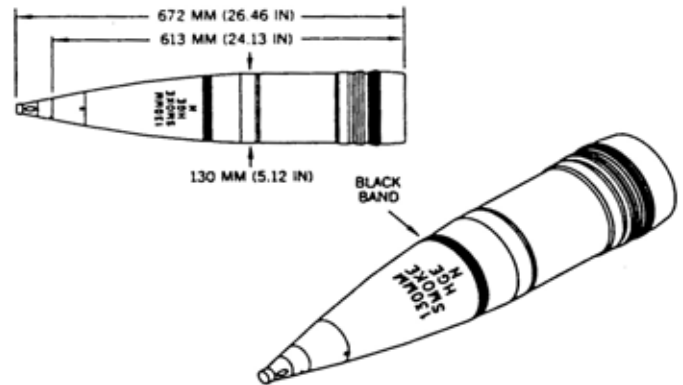

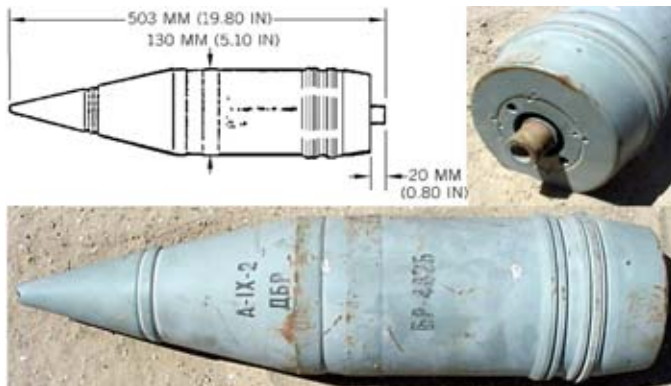

## U.S.S.R. PROJECTILE, 130-MM, APHE-T, BR-482B

Ordnance used with:  
 DBR, PROJECTILE, BD  
 DBR-2, PROJECTILE, BD  
 M-1954, 130MM, FIELD GUN  
 M46, 130MM, FIELD GUN  
 TYPE 59, 130MM, FIELD GUN  
 TYPE 59-1, 130MM, FIELD GUN  
 M46, 130-MM, CARTRIDGE

N.E.W. 130.00 G

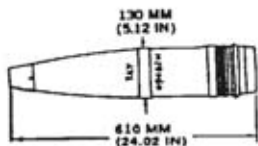

## U.S.S.R. PROJECTILE, 130-MM, FRAG, HE, MODEL OF-482M

Ordnance used with:  
 TYPE 59, 130MM, PROPELLING CHARGE, REDUCED VARIABLE  
 ZH 482U, 130MM, PROPELLING CHARGE, REDUCED  
 RGM-2, PROJECTILE, PD  
 RGM-3, PROJECTILE, PD  
 RGM-6, PROJECTILE, PD  
 AR 7 (SIGNAL), PROJECTILE, PROXIMITY/PD  
 V-429, PROJECTILE, PD





## U.S.S.R. PROJECTILE, 130-MM, HE, OF33

Ordnance used with:  
V-429, PROJECTILE, PD  
V-429E, PROJECTILE, PD  
B-90, PROJECTILE, MTSQ  
V-90, PROJECTILE, MTSQ  
AR 5, PROJECTILE, PROXIMITY  
AR-5, PROJECTILE, PROXIMITY

N.E.W. 4.30 KG

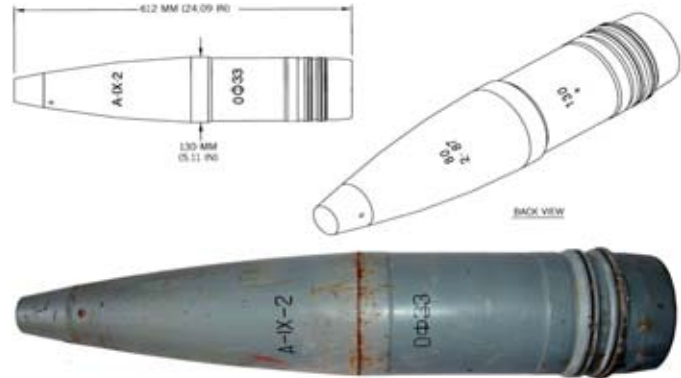

## U.S.S.R. PROJECTILE, 130-MM, ILLUMINATION, S2

Ordnance used with:  
T-90, PROJECTILE, MT  
B-90, PROJECTILE, MTSQ  
V-90, PROJECTILE, MTSQ

N.E.W. 107.00 G

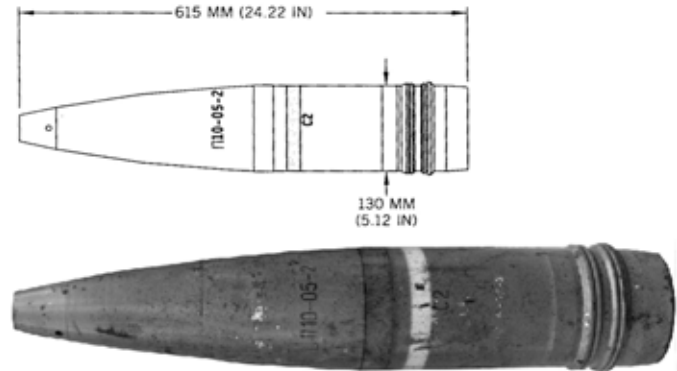

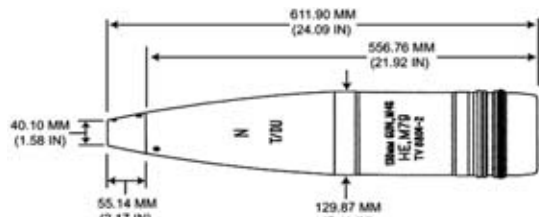

## YUGOSLAV PROJECTILE, 130-MM, HE, M79

Ordnance used with:  
 AU-18P1, PROJECTILE, PD  
 UTIU M72, PROJECTILE, PD  
 UTIU M85, PROJECTILE, PD  
 M-1954, 130MM, FIELD GUN  
 M46, 130MM, FIELD GUN  
 TYPE 59, 130MM, FIELD GUN  
 TYPE 59-1, 130MM, FIELD GUN

N.E.W. 3.66 KG

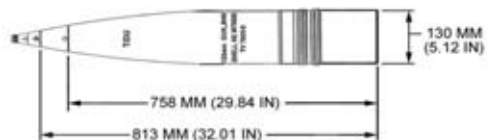

## YUGOSLAV PROJECTILE, 130-MM, HE-BB, M79BB

Ordnance used with:  
 RGM-2M, PROJECTILE, PD

## CZECHOSLOVAKIAN CARTRIDGE, 100-MM, HEAT, JPRSV

Ordnance used with:  
PRSV, 100-MM, HEAT  
NZ-42, PROJECTILE, PIBD

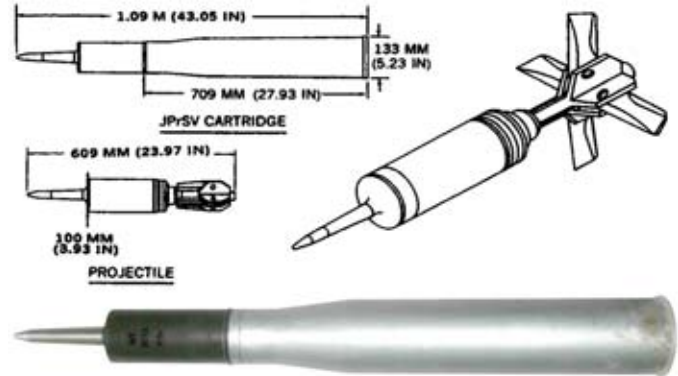

## IRAQI CARTRIDGE, 100-MM, HE-FRAG, UO-415

Ordnance used with:  
O-415, 100-MM, HE-FRAG  
KS-19M2, AIR DEFENSE GUN, 100MM  
UO-415, 100-MM, HE, FRAG (IRAQI MODEL)

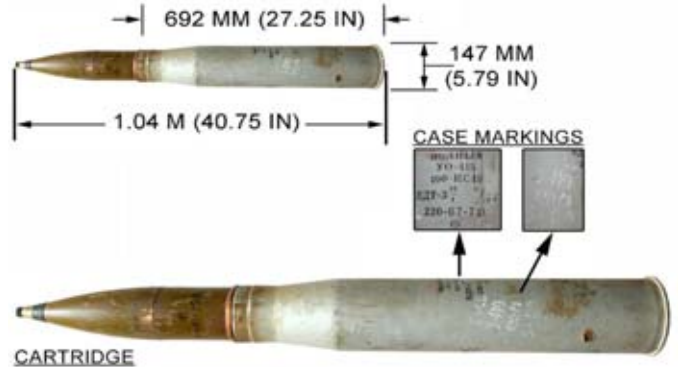

N.E.W. 7.05 KG



### IRAQI PROPELLING CHARGE, 122-MM, FULL, HGC

Ordnance used with:  
HGC, 122MM, HE  
HGE, 122MM, HE



### IRAQI PROPELLING CHARGE, 122-MM, REDUCED, HGC

Ordnance used with:  
HGC, 122MM, HE  
HGE, 122MM, HE



## ROMANIAN CARTRIDGE, 100-MM, HEAT-T, HXG

Ordnance used with:  
GPV-2, PROJECTILE, PIBD, SPITBACK  
HXG, 100-MM, HEAT-T



## ROMANIAN CARTRIDGE, 100-MM, HEAT-T, UBK-412R

Ordnance used with:  
BK412R, 100-MM, HEAT-T



**U.S.S.R. CARTRIDGE, 100-MM, APFSDS-T, UBM-2**



Ordnance used with:  
BM-2, 100-MM, APFSDS

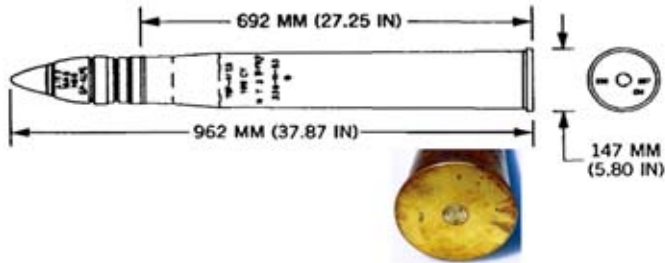

**U.S.S.R. CARTRIDGE, 100-MM, APHE OR APHE-T, UBR-412B**

Ordnance used with:  
DBR-2, PROJECTILE, BD  
BR-412B, 100-MM, APHE-T  
MD-8, PROJECTILE, BD



## U.S.S.R. CARTRIDGE, 100-MM, APHE OR APHE-T, UBR-412D

Ordnance used with:  
DBR, PROJECTILE, BD  
DBR-2, PROJECTILE, BD  
BR-412D (VARIANT), 100-MM, APHE-T  
BR-412D, 100-MM, APHE-T  
MD-8, PROJECTILE, BD  
KS-19M2, AIR DEFENSE GUN, 100MM



---

## U.S.S.R. CARTRIDGE, 100-MM, APHE-T, UBR-412

Ordnance used with:  
MD-8, PROJECTILE, BD  
BR-412, 100-MM, APHE-T  
KS-19M2, AIR DEFENSE GUN, 100MM

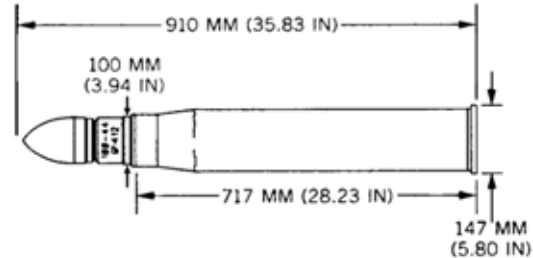

## U.S.S.R. CARTRIDGE, 100-MM, HE, FRAG, UOF-412



Ordnance used with:  
NSC-1, PROJECTILE, PDS  
OF-412, 100-MM, FRAG-HE  
TYPE 412, PROJECTILE, 100 MM, HE  
RGM, PROJECTILE, PD  
RGM-2, PROJECTILE, PD  
RGM-3, PROJECTILE, PD  
RGM-6, PROJECTILE, PD



## U.S.S.R. CARTRIDGE, 100-MM, HEAT, UBK-2



Ordnance used with:  
BK-3, 100-MM, HEAT-FS-T





## U.S.S.R. CARTRIDGE, 100-MM, HEAT-FS, MODEL UBK-4M

Ordnance used with:  
GPV-2, PROJECTILE, PIBD, SPITBACK  
3BK-5M, 100MM, HEAT-FS-T  
3BK5M, 100MM, HEAT-FS-T  
BK-5M, 100MM, HEAT-FS-T  
BK5M, 100MM, HEAT-FS-T  
ZBK-5M, 100MM, HEAT-FS-T

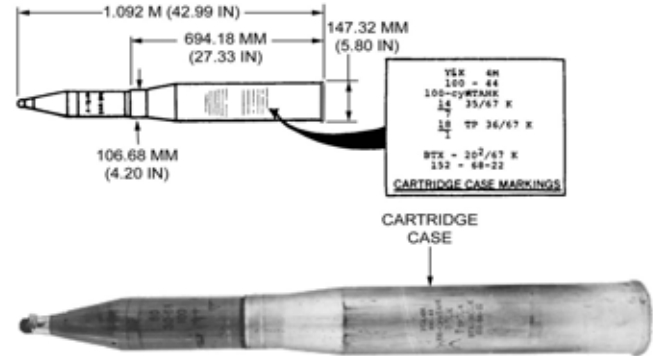

## U.S.S.R. CARTRIDGE, 122-MM, HEAT-FS-T, 3UBK-9

Ordnance used with:  
3BK-13, 122-MM, HEAT-FS-T  
BK-13, 122-MM, HEAT-FS-T  
BK13, 122-MM, HEAT-FS-T  
V-15, FUZE, PROJECTILE, PIBD



## U.S.S.R. CARTRIDGE, 100-MM, APFSDS-T, UBM-8

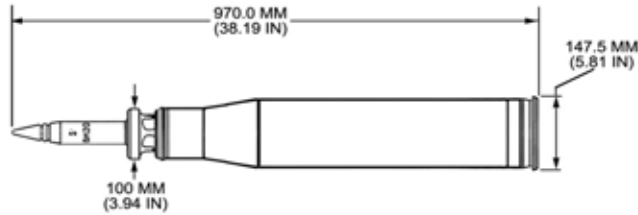

Ordnance used with:  
BM-20, 100-MM, APFSDS



## UNKNOWN COUNTRY PROPELLING CHARGE, 122-MM, REDUCIBLE, MODEL UNKNOWN

Ordnance used with:  
TYPE 54, 122-MM, HE



N.E.W. 2.75 KG

## CHINESE PROJECTILE, 152-MM, HE, TYPE 66

Ordnance used with:

ML-4

ML4, PROJECTILE, PD

ML-5

ML5, PROJECTILE, PD

LIU-4, PROJECTILE, PD

NO. 2, 152-MM, PROPELLING CHARGE (REDUCED)

UNKNOWN, 152-MM, PROPELLING CHARGE

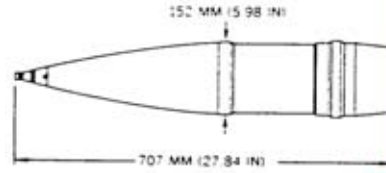

## CHINESE PROJECTILE, 152-MM, HE, TYPE 66

Ordnance used with:

NO. 2, 152-MM, PROPELLING CHARGE (REDUCED)

UNKNOWN, 152-MM, PROPELLING CHARGE

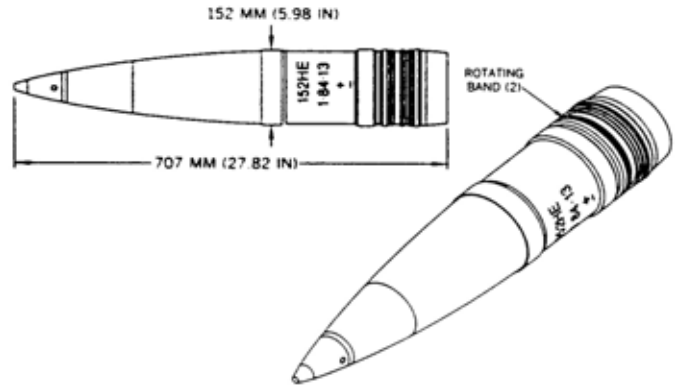

N.E.W. 5.30 KG

## CHINESE PROJECTILE, 152-MM, HE, TYPE 83

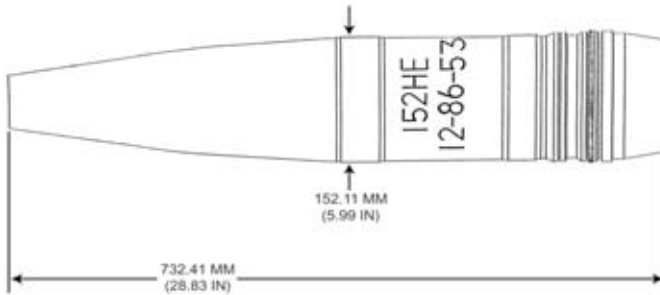

Ordnance used with:  
ML-7, PROJECTILE, PD  
ML7, PROJECTILE, PD

N.E.W. 6.60 KG

## CHINESE PROJECTILE, 152-MM, HE-FRAG, TYPE 66 MODIFIED

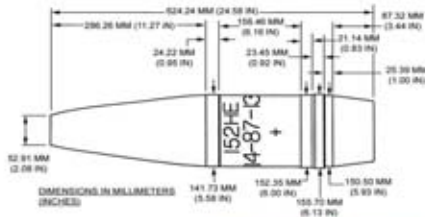

Ordnance used with:  
MD-11  
MD11, PROJECTILE, PROXIMITY/PD  
MD-11D  
MD11D, PROJECTILE, PROXIMITY  
MD-81  
MD81, PROJECTILE, PROXIMITY  
ML-7, PROJECTILE, PD

N.E.W. 5.33 KG



**CHINESE PROJECTILE, 152-MM, INCENDIARY, TYPE 66**

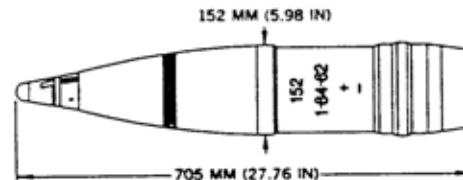

N.E.W. 4.20 KG

**IRAQI PROJECTILE, 152-MM, HE, MODEL UNKNOWN**

Ordnance used with:  
V-429, PROJECTILE, PD  
B-90, PROJECTILE, MTSQ  
V-90, PROJECTILE, MTSQ  
MODEL UNKNOWN, 152-MM, PROPELLING CHARGE

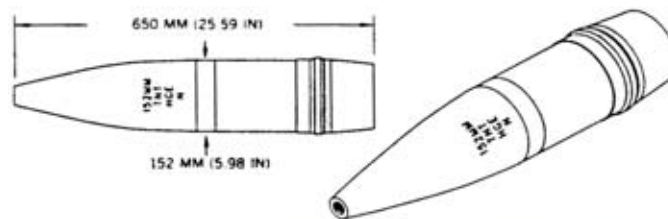

N.E.W. 6.20 KG

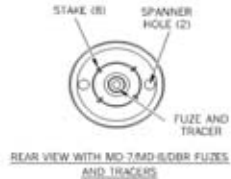
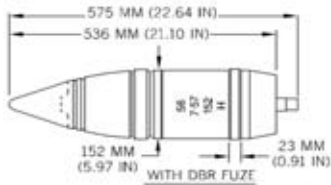

## U.S.S.R. PROJECTILE, 152-MM, APHE-T, BR-540B

Ordnance used with:  
 DBR, PROJECTILE, BD  
 DBR-2, PROJECTILE, BD  
 MD-7, FUZE, PROJECTILE, BD  
 MD-8, PROJECTILE, BD

N.E.W. 471.00 G

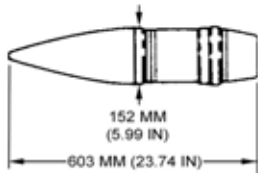

## U.S.S.R. PROJECTILE, 152-MM, CP, MODEL G-530

Ordnance used with:  
 DBT, PROJECTILE, BD  
 KTD, PROJECTILE, BD  
 KTD-2, PROJECTILE, BD

N.E.W. 5.10 KG

**U.S.S.R. PROJECTILE, 152-MM, FRAG/HE, MODEL OF-540**

Ordnance used with:  
D-1, PROJECTILE, TSQ  
RGM-2, PROJECTILE, PD  
RGM-3, PROJECTILE, PD  
AR 7 (SIGNAL), PROJECTILE, PROXIMITY/PD  
V-429, PROJECTILE, PD  
V-429E, PROJECTILE, PD  
B-90, PROJECTILE, MTSQ  
N.E.W. 5.70 KG

---

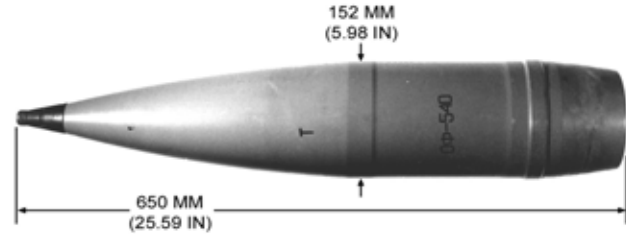

**U.S.S.R. PROJECTILE, 152-MM, HE, 3OF64**

N.E.W. 7.80 KG

---

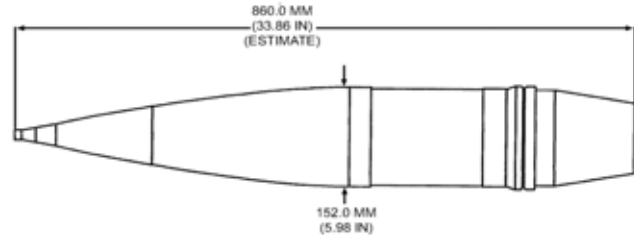

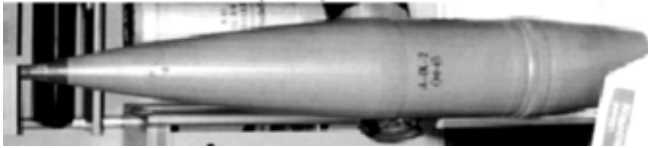
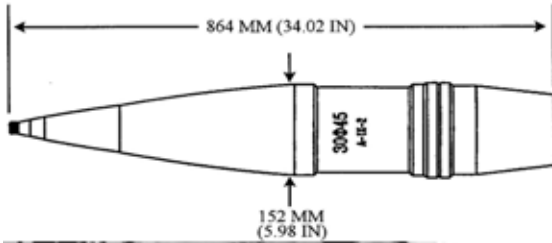

**U.S.S.R. PROJECTILE, 152-MM, HE, BASE BLEED, 30F45**

Ordnance used with:  
RGM-2M, PROJECTILE, PD

N.E.W. 7.65 KG

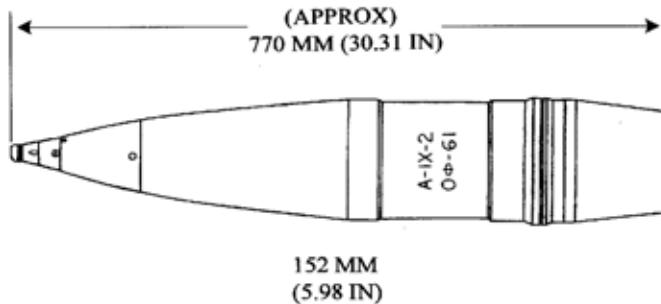

**U.S.S.R. PROJECTILE, 152-MM, HE, BASE-BURN, OF-61**

Ordnance used with:  
RGM-2, PROJECTILE, PD  
RGM-3, PROJECTILE, PD  
V-429, PROJECTILE, PD  
V-429E, PROJECTILE, PD

N.E.W. 9.14 KG



**U.S.S.R. PROJECTILE, 152-MM, HE, SANTIMETR  
30F38**

Ordnance used with:  
T-90, PROJECTILE, MT

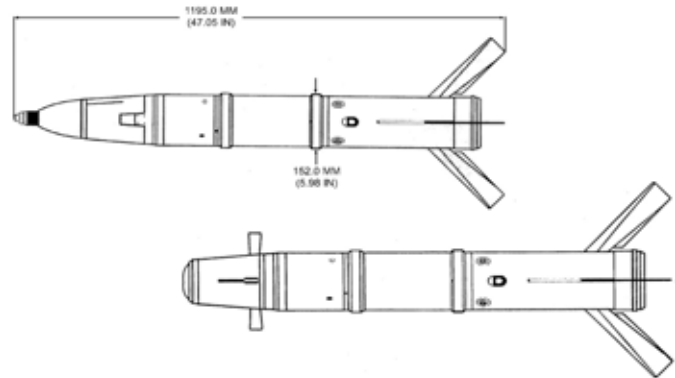

N.E.W. 5.80 KG

**U.S.S.R. PROJECTILE, 152-MM, HE-FRAG,  
(TWO-PIECE), MODEL OF-540**

Ordnance used with:  
RGM, PROJECTILE, PD  
D-1-U, PROJECTILE, TSQ  
D-1U, PROJECTILE, TSQ

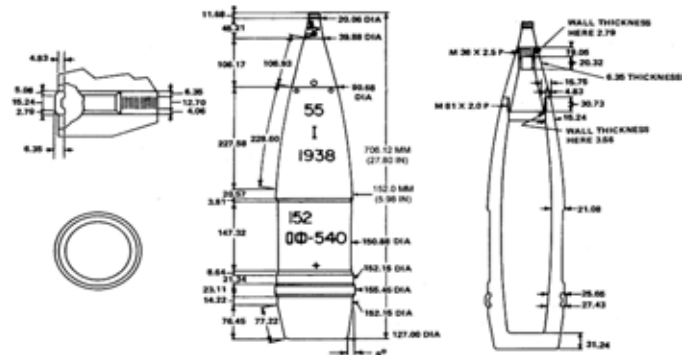

N.E.W. 6.24 KG



### U.S.S.R. PROJECTILE, 152-MM, HE-FRAG, OF25

Ordnance used with:  
RGM-2M, PROJECTILE, PD  
T-90, PROJECTILE, MT  
B-90, PROJECTILE, MTSQ  
V-90, PROJECTILE, MTSQ

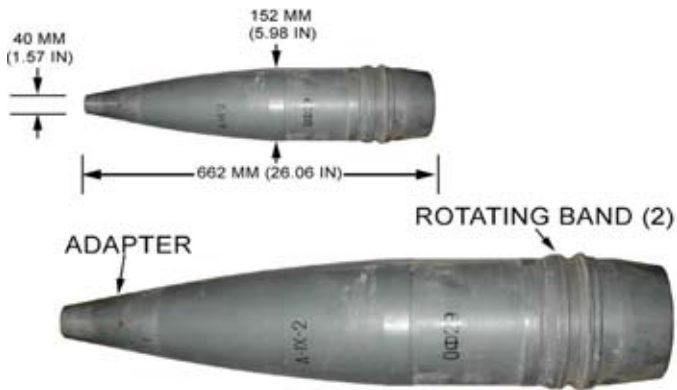

### U.S.S.R. PROJECTILE, 152-MM, HE-FRAG, OF29

Ordnance used with:  
V-429, PROJECTILE, PD

## U.S.S.R. PROJECTILE, 152-MM, HEAT-T, BP-540

Ordnance used with:  
GKV, PROJECTILE, PIBD  
GPV-3, PROJECTILE, PIBD

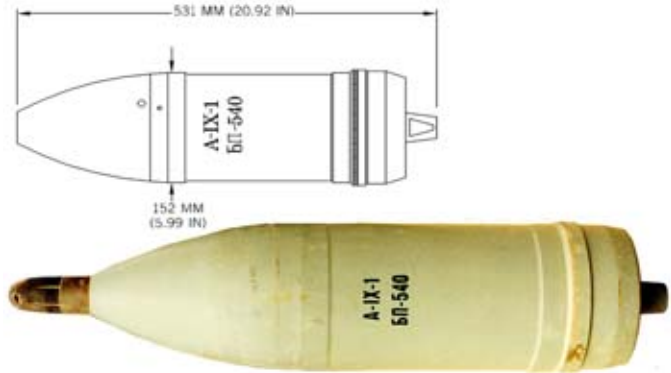

N.E.W. 4.02 KG

## U.S.S.R. PROJECTILE, 152-MM, ICM, BASE BLEED, 3-O-23

Ordnance used with:  
UNKNOWN, PROJECTILE, HEAT

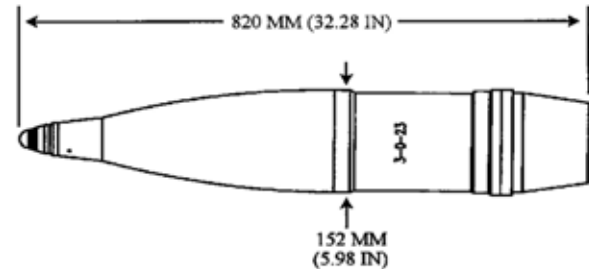

N.E.W. 1.89 KG



### UNKNOWN COUNTRY PROJECTILE, 152-MM, HE, H-EX-S

Ordnance used with:  
RGM-2, PROJECTILE, PD

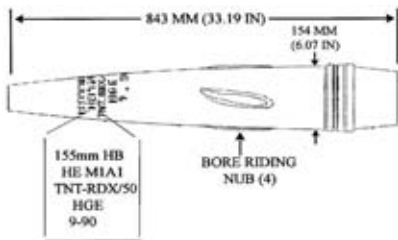

### IRAQI PROJECTILE, 155-MM, HE, M1A1

Ordnance used with:  
GHN-45, GUN, HOWITZER, 155MM, TOWED

N.E.W. 8.54 KG

## CANADIAN PROJECTILE, 155-MM, HE-FRAG, MK 10 MODEL 2

Ordnance used with:  
M557, FUZE, PROJECTILE, PD  
M572, FUZE, PROJECTILE, PD  
M728, FUZE, PROJECTILE, PROXIMITY  
M732 PROJECTILE, PROXIMITY  
M514A1E1, FUZE, PROJECTILE, PROX  
GHN-45, GUN, HOWITZER, 155MM, TOWED

N.E.W. 8.80 KG

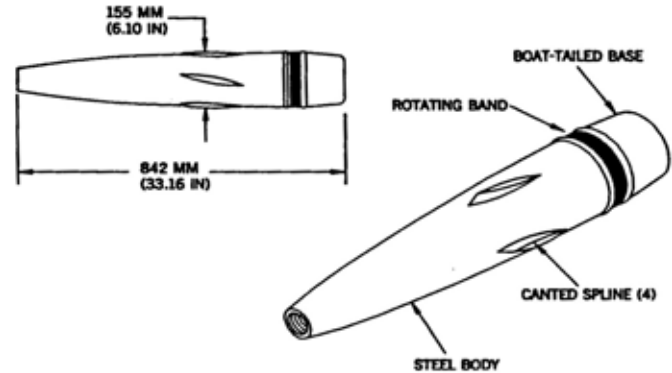

## FRENCH PROJECTILE, 155-MM, HE, MODEL 56, MODEL 56/69

Ordnance used with:  
M500, FUZE, PROJECTILE, MTSQ  
M51A4, FUZE, PROJECTILE, PD  
M51A5, FUZE, PROJECTILE, PD  
M520, FUZE, PROJECTILE, MTSQ  
M520A1, FUZE, PROJECTILE, MTSQ  
M557, FUZE, PROJECTILE, PD  
M564, FUZE, PROJECTILE, MTSQ

N.E.W. 9.05 KG

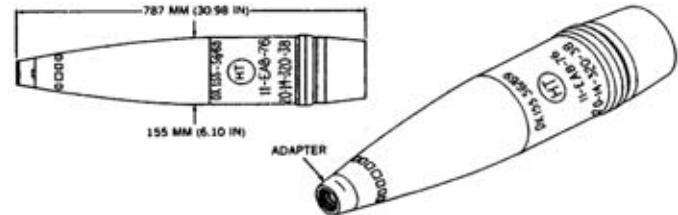

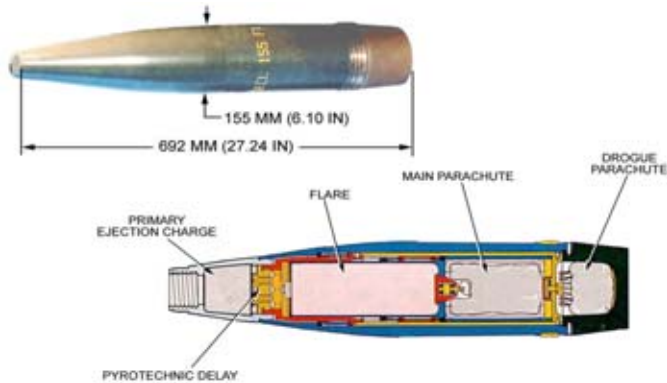

## FRENCH PROJECTILE, 155-MM, ILLUMINATION, OECL 155 F1

Ordnance used with:

- M565, PROJECTILE, MT
- M565E1, PROJECTILE, MT
- FU DE F2, PROJECTILE, MTSQ
- M548, FUZE, PROJECTILE, MTSQ
- FU ELN DE H1, PROJECTILE, ET



## FRENCH PROJECTILE, 155-MM, OE 155 F1, HE

Ordnance used with:

- M500, FUZE, PROJECTILE, MTSQ
- M51A4, FUZE, PROJECTILE, PD
- M51A5, FUZE, PROJECTILE, PD
- M520, FUZE, PROJECTILE, MTSQ
- M520A1, FUZE, PROJECTILE, MTSQ
- M557, FUZE, PROJECTILE, PD
- M564, FUZE, PROJECTILE, MTSQ

N.E.W. 8.80 KG

## FRENCH PROJECTILE, 155-MM, SMOKE, WP, MODEL F2

Ordnance used with:  
M557, FUZE, PROJECTILE, PD  
FUI 56, PROJECTILE, PD  
MFUI 56, PROJECTILE, PD

N.E.W. 220.00 G

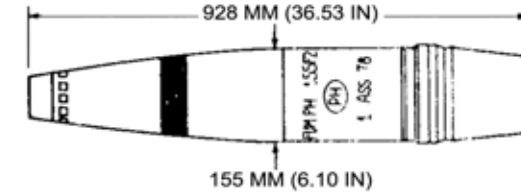

## FRENCH PROJECTILE, 155-MM, SMOKE, WP, MODEL FIA

Ordnance used with:  
M557, FUZE, PROJECTILE, PD  
M557E1, PD  
FUI F4, PROJECTILE, PD  
TYPE F4, PD  
FUI 56, PROJECTILE, PD  
FUI F3, PROJECTILE, PD  
TYPE F3, PD

N.E.W. 150.00 G

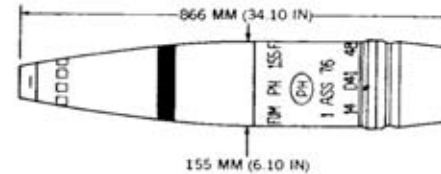



## GREEK PROJECTILE, 155-MM, HE-BB, ERMIS

Ordnance used with:  
 M572, FUZE, PROJECTILE, PD  
 M582, FUZE, PROJECTILE, MTSQ  
 M732 PROJECTILE, PROXIMITY  
 M739, FUZE, PROJECTILE, PD

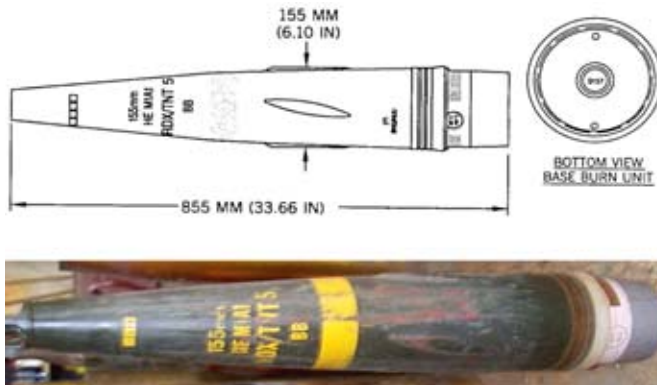

## SOUTH AFRICAN PROJECTILE, 155-MM, HE, M1A1

Ordnance used with:  
 M557, FUZE, PROJECTILE, PD  
 M739, FUZE, PROJECTILE, PD  
 ZELAR, PROJECTILE, PROXIMITY/IMPACT  
 M8513, PROJECTILE, PROXIMITY/PD  
 M 841A1, PROJECTILE, PDSQ  
 M841A1, PROJECTILE, PDSQ  
 M8513A1, PROJECTILE, PROXIMITY/PD  
 N.E.W. 9.20 KG



## SOUTH AFRICAN PROJECTILE, 155-MM, ILLUMINATION, M1A1

Ordnance used with:  
M8611A1, FUZE, PROJECTILE, ET  
MODEL UNKNOWN, 155-MM, BASE BLEED UNIT  
M50A1, 155-MM, PROPELLING CHARGE  
M53A2, 155 MM, PROPELLING CHARGE, MODULAR  
M91A1, 155-MM, PROPELLING CHARGE  
M92A1, 155-MM, PROPELLING CHARGE, BIMODULAR  
M62A1, 155 MM, PROPELLING CHARGE UNIMODULAR

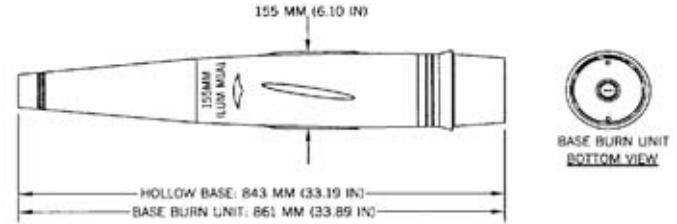

## SOUTH AFRICAN PROJECTILE, 155-MM, SMOKE, HC, M2A1

Ordnance used with:  
M8611A1, FUZE, PROJECTILE, ET  
MODEL UNKNOWN, 155-MM, BASE BLEED UNIT  
M50A1, 155-MM, PROPELLING CHARGE  
M53A2, 155 MM, PROPELLING CHARGE, MODULAR  
M91A1, 155-MM, PROPELLING CHARGE  
M92A1, 155-MM, PROPELLING CHARGE, BIMODULAR  
M62A1, 155 MM, PROPELLING CHARGE UNIMODULAR

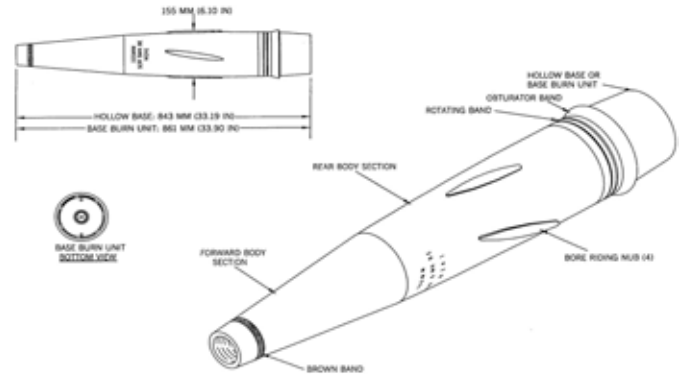

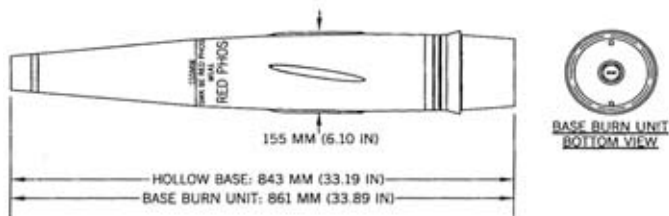

## SOUTH AFRICAN PROJECTILE, 155-MM, SMOKE, RP, M1A1

Ordnance used with:

M8611A1, FUZE, PROJECTILE, ET  
 MODEL UNKNOWN, 155-MM, BASE BLEED UNIT  
 M50A1, 155-MM, PROPELLING CHARGE  
 M53A2, 155 MM, PROPELLING CHARGE, MODULAR  
 M91A1, 155-MM, PROPELLING CHARGE  
 M92A1, 155-MM, PROPELLING CHARGE, BIMODULAR  
 M62A1, 155 MM, PROPELLING CHARGE UNIMODULAR



N.E.W. 1108.00 G

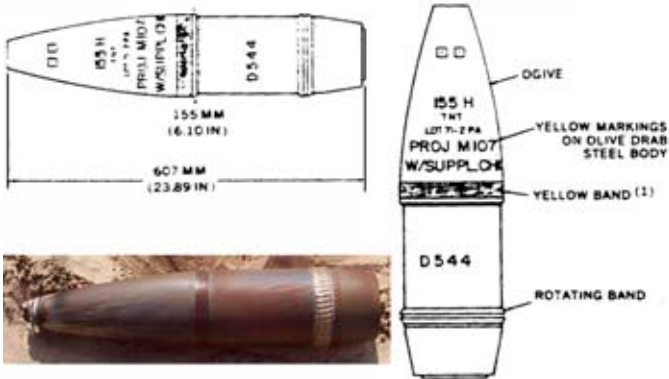

## U.K. PROJECTILE, 155-MM, HE, M107

Ordnance used with:

M507, FUZE, PROJECTILE, PD  
 M557, FUZE, PROJECTILE, PD  
 M732 PROJECTILE, PROXIMITY  
 M83, PROJECTILE, CP  
 APP155, PROJECTILE, PROXIMITY  
 APP155, PROJECTILE, PROXIMITY/PD (ESTHER)  
 L85A2, PROJECTILE, PD

## U.S. PROJECTILE, 155-MM, HE, M107

Ordnance used with:

M48, PROJECTILE, PD

M48A1, PROJECTILE, PD

M48A2, FUZE, PROJECTILE, PD

M48A3, FUZE, PROJECTILE, PD

M500, FUZE, PROJECTILE, MTSQ

M501, FUZE, PROJECTILE, MTSQ

M501A1, FUZE, PROJECTILE, MTSQ

N.E.W. 7.13 KG



## U.S. PROJECTILES, 155-MM, HERA, M549 & M549A1

Ordnance used with:

M48, PROJECTILE, PD

M48A1, PROJECTILE, PD

M48A2, FUZE, PROJECTILE, PD

M48A3, FUZE, PROJECTILE, PD

M501, FUZE, PROJECTILE, MTSQ

M501A1, FUZE, PROJECTILE, MTSQ

M507, FUZE, PROJECTILE, PD

N.E.W. 6.80 KG

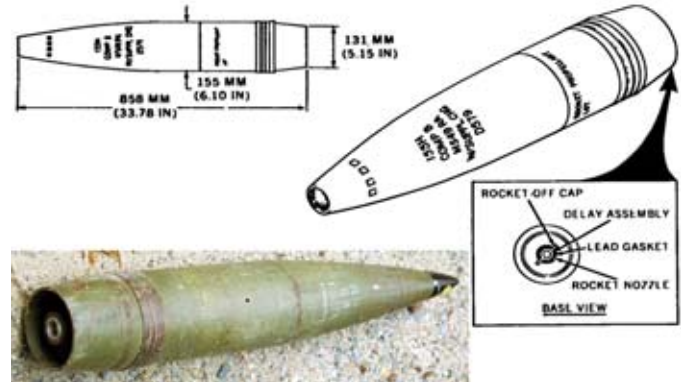



**CHINESE PROJECTILE, 160-MM, HE, MORTAR, MODEL UNKNOWN**

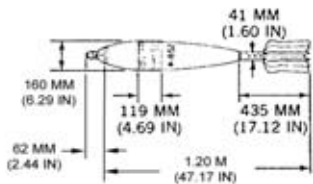

**U.S.S.R. PROJECTILE, 160-MM, MORTAR, HE, MODEL F-852**

Ordnance used with:  
GVM, FUZE, PROJECTILE, PD  
GVMZ, FUZE, PROJECTILE, PD  
GVMZ-1, FUZE, PROJECTILE, PD  
GVMZ-7, PROJECTILE, PD



N.E.W. 7.39 KG

**U.S.S.R. PROJECTILE, 160-MM, MORTAR, HE, MODEL F-853A**

Ordnance used with:  
GVMZ-7, PROJECTILE, PD

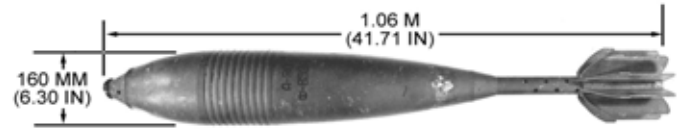

N.E.W. 7.73 KG

---

**U.S.S.R. PROJECTILE, 160-MM, MORTAR, HE, MODEL F-853U**

Ordnance used with:  
GVMZ-7, PROJECTILE, PD

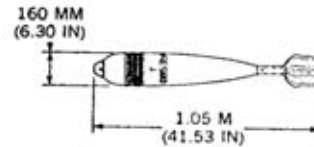

N.E.W. 8.99 KG

---

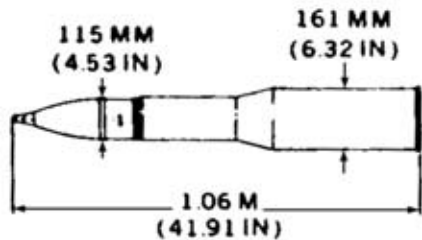

### U.S.S.R. CARTRIDGE, 115-MM, HE, FRAG, MODEL UOF-6

Ordnance used with:  
OF-18, 115-MM, HE-FRAG  
V-429, PROJECTILE, PD  
V-429E, PROJECTILE, PD

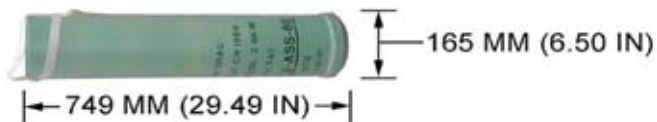

### FRENCH PROPELLING CHARGE, 155-MM, VARIABLE, CN155AU



**U.S.S.R. CARTRIDGE, 115-MM, HVAP-FS-DS-T MODEL  
UBM-5**

Ordnance used with:  
BM-6, 115-MM, APFSDS-T

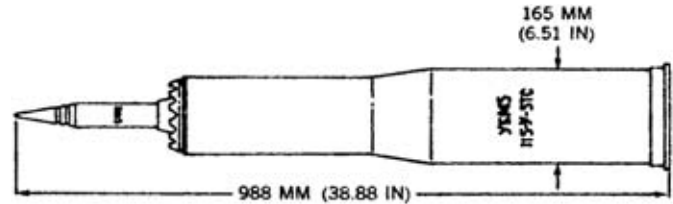

**CHINESE PROPELLING CHARGE (REDUCED),  
152-MM, NO. 2**

Ordnance used with:  
TYPE 66, 152-MM, HE  
TYPE 66, 152 MM, HE  
TYPE 66 MODIFIED, 152 MM, HE



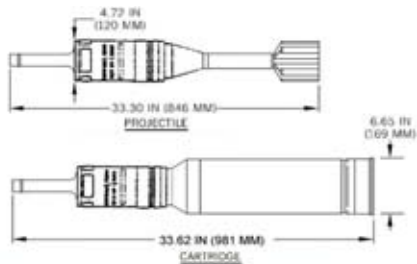

## U.S. CARTRIDGE, 120-MM, HEAT-MP-T, M830

Ordnance used with:  
M830, 120-MM, CARTRIDGE, HEAT-MP-T  
M830, 120-MM, HEAT-MP-T



N.E.W. 32.00 LB

## U.S.S.R. CARTRIDGE, 115-MM, FS, HEAT, MODEL UBK-3M



Ordnance used with:  
BK-4M, 115-MM, HEAT-FS  
GPV-2, PROJECTILE, PIBD, SPITBACK

N.E.W. 6.78 KG



## U.S.S.R. PROPELLING CHARGE, 125-MM, ZH 40

Ordnance used with:  
BK-14M, 125-MM, HEAT-T  
BM-15, 125-MM, APFSDS-T  
OF-19, 125-MM, HE/FRAG  
OF19, 125-MM, HE/FRAG  
BM-18, 125MM, APFSDS-T  
VBM-7, 125-MM, CARTRIDGE, APFSDS-T

N.E.W. 5.40 KG

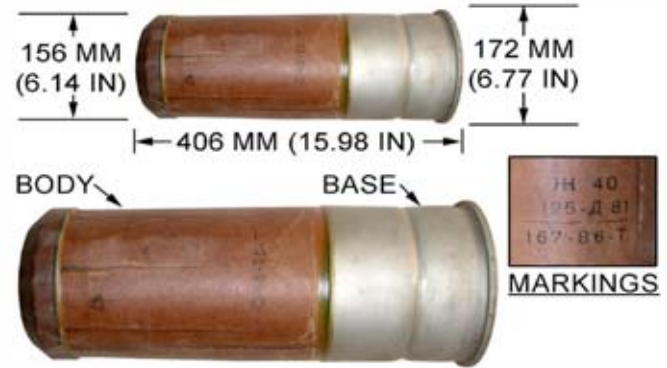

## IRAQI PROPELLING CHARGE, 130-MM, FULL, HGE

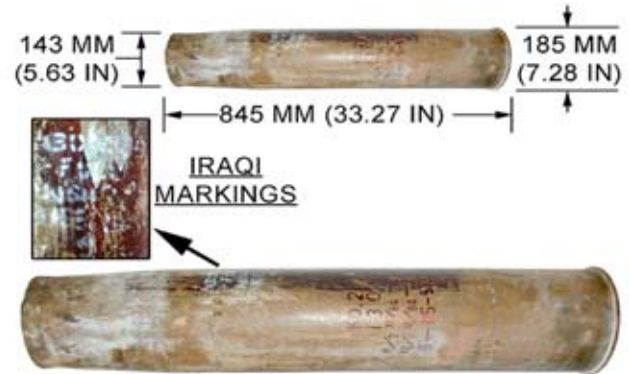

N.E.W. 13.80 KG



## IRAQI PROPELLING CHARGE, 130-MM, REDUCED,

Ordnance used with:  
HE482M, 130-MM, HE

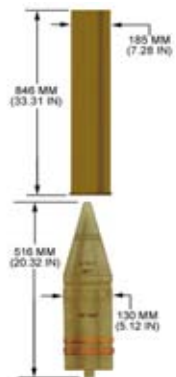

## U.S.S.R. CARTRIDGE, 130-MM, M46

Ordnance used with:  
TYPE 59, 130-MM, ILLUM  
TYPE 59-1, 130-MM, SMOKE  
BR-482B, 130-MM, APHE-T  
DBR, PROJECTILE, BD  
DBR-2, PROJECTILE, BD  
DTS-1, 130-MM, SMOKE, WP  
OF-482M, 130-MM, FRAG-HE

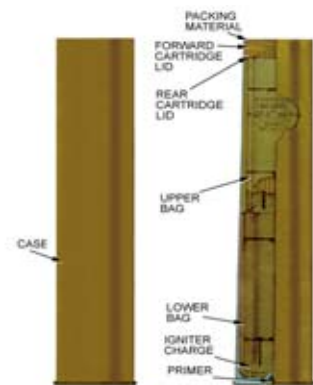

**U.S.S.R. PROPELLING CHARGE, 152-MM, ZH 47**



N.E.W. 19.60 KG

**U.S.S.R. PROJECTILE, 240-MM, HE, FIN-STABILIZED, MODEL F864**

Ordnance used with:  
GVMZ-7, PROJECTILE, PD  
M16, PROJECTILE, PD

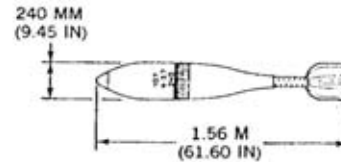

N.E.W. 31.93 KG